



Fraunhofer

IFAM

FRAUNHOFER INSTITUTE FOR MANUFACTURING TECHNOLOGY AND ADVANCED MATERIALS IFAM



ANNUAL REPORT
2017/2018

ANNUAL REPORT

2017/2018

FOREWORD

1 *Institute directors Prof. Dr.-Ing. habil. Matthias Busse (left) and Prof. Dr. Bernd Mayer. (© GfG Bremen / Thomas Kleiner)*



Dear Reader,

2017 was a very successful year for Fraunhofer IFAM. For a number of years we have been growing from strength to strength, and in order to continue doing so, we have implemented a strategy process to sharpen the scientific-technical capabilities of the institute. Fraunhofer IFAM is constantly rising to the challenge of addressing the changing technological demands and shifting markets. Energy, raw materials, medicine, mobility, automation, digitalization – these issues are playing a crucial role in global society. Through our core competences we are concentrating on the development of application-oriented solutions which we then offer to various sectors in industry.

Fraunhofer IFAM has built up a strong system competence in electromobility, which is increasingly being demanded by all transport sectors. This segment has become one of the core competences of the institute. In addition to energy system analyses, the focus also lies on energy storage as well as electrical drives and the testing of electrical machines. The future demands placed on batteries and fuel cells will require a broad spectrum of technical solutions. In close cooperation with the Battery LabFactory Braunschweig, the Fraunhofer-Gesellschaft and the State of Lower Saxony are planning a Fraunhofer Project Center for Energy Storage and Systems in Braunschweig*. Fraunhofer IFAM is both the driving force and one of the coordinating organizations of this new location.

Strategically important technologies are also being pursued in the field of aviation. The institute is closely networked with core partners from the fields of science and business at both a national and a European level. Together with the aircraft manufacturer Airbus, IFAM is realizing the "Future Factory" with its digitized "End-to-End" data stream. The contributions of the institute comprise in particular automation, human-robot cooperation, and the logistics in the cabin assembly as well as robotic joining. Meanwhile, 3D printing technologies and functional printing offer unique possibilities for digital manufacture both in the aviation sector and in other industries.

For the maritime sector, Fraunhofer IFAM is advancing development in corrosion protection, functional coatings, and adhesive bonding for the construction of ships. Last year, our facilities were expanded with the installation of testing sites on the island of Sylt, at the "Alte Weser" lighthouse, and the offshore island of Helgoland, enabling tests to be conducted under real-world conditions. Our new center for the inline pre-treatment of surfaces completes the range of services we offer to our industrial and research partners.

In the business segment of medical technology, IFAM has been able to initiate projects of importance with a focus on preventing infection in orthopedic practice. Together with the Charité – Universitätsmedizin Berlin, antibiosis is being investigated with the aim of developing technological and social innovations. In parallel, an internal project is working on the synergistic effects of metal ions and antibiotics, in conjunction with numerous university clinics.

In all business segments the institute is making an important contribution to technological change, especially in close cooperation with strong actors. In this context, we would especially like to thank our over 600 employees, who are driving these new developments with great passion and commitment. Furthermore, for joining us in designing for the future as well as for the trust placed in us, we would like to thank our customers and project partners.

The following annual report offers a cross-section of selected research results from our efforts at the institute. We hope you enjoy reading about them.

Matthias Busse

Bernd Mayer

*Under construction

CONTENTS

FOREWORD

2

PROFILE OF FRAUNHOFER IFAM

The Fraunhofer-Gesellschaft

6

Brief portrait and organigram

8

The institute in figures

9

Quality management

11

The Advisory Board

13

Business segments

14

Fields of activity and contacts

17

Shaping and Functional Materials

25

Adhesive Bonding Technology and Surfaces

29

METALLIC MATERIALS

Core competence

33

Fused filament fabrication –
versatile and cost-effective

34

Additive manufacturing of technical metal springs

35

POLYMERIC MATERIALS

Core competence

37

Valorization of bio-based raw materials

38

Functional integration in FRP with
digital printing

39

SURFACE TECHNOLOGY

Core competence

41

Surfaces for medical technology

42

Digitalization in the quality assurance
of surfaces

43

Fuel efficiency through the laser pre-treatment
of titanium

45

ADHESIVE BONDING

Core competence

47

Fatigue behavior of adhesively bonded steel joints
under non-reversed loads

48

Studying adhesive bonding technology:
in-service training

50

Rods glued into hardwood

51



SHAPING AND FUNCTIONALIZATION

Core competence	53
Textile hollow fiber structures for thermal applications	54
Efficient processes for the production of complex shapes	55

ELECTROMOBILITY

Core competence	57
New approaches to powder metallurgy gas-solid energy storage	58
Wheel hub drive enables optimum recuperation	59

AUTOMATION AND DIGITALIZATION

Core competence	61
Innovationen in fiber-metal laminate (FML) production for aircraft construction	62

PEOPLE AND MOMENTS

New business segment pools core competences for maritime technologies	65
Fraunhofer builds new project center for energy storage research	66
Automated vertical tail plane assembly awarded	67
First composite engineers certified	68
New seminar for adhesive bonding manufacture	69
Fabio La Mantia receives ERC Consolidator Grant	70
Network project enhances cooperation between JAXA and Fraunhofer	71
futureAM – Next Generation Additive Manufacturing	72
Day of lightweight construction in Stade – a market for future technologies	73
New center for inline surface pre-treatment inaugurated	74

COOPERATIVE AND SCIENTIFIC

Cooperative and scientific	76
Fraunhofer Group Materials, Components – Materials	77
Fraunhofer Alliances	78

EDITORIAL NOTES	80
-----------------	----

THE FRAUNHOFER-GESELLSCHAFT

Research of practical utility lies at the heart of all activities pursued by the Fraunhofer-Gesellschaft. Founded in 1949, the research organization undertakes applied research that drives economic development and serves the wider benefit of society. Its services are solicited by customers and contractual partners in industry, the service sector, and public administration.

At present, the Fraunhofer-Gesellschaft maintains 72 institutes and research units. The majority of the 25,000 staff are qualified scientists and engineers, who work with an annual research budget of 2.3 billion euros. Of this sum, 2 billion euros is generated through contract research. More than 70 percent of the Fraunhofer-Gesellschaft's contract research revenue is derived from contracts with industry and from publicly financed research projects. Almost 30 percent is contributed by the German federal and state governments in the form of base funding, enabling the institutes to work in advance on solutions to problems that will not become acutely relevant to industry and society until five or ten years from now.

International collaborations with excellent research partners and innovative companies around the world ensure direct access to regions of the greatest importance to present and future scientific progress and economic development.

With its clearly defined mission of application-oriented research and its focus on key technologies of relevance to the future, the Fraunhofer-Gesellschaft plays a prominent role in the German and European innovation process. Applied research has a knock-on effect that extends beyond the direct benefits perceived by the customer: Through their research and development work, the Fraunhofer Institutes help to reinforce the competitive strength of the economy in their local region and throughout Germany and Europe. They do so by promoting innovation, strengthening the technolog-

ical base, improving the acceptance of new technologies, and helping to train the urgently needed next generation of scientists and engineers.

As an employer, the Fraunhofer-Gesellschaft offers its staff the opportunity to develop the professional and personal skills that will allow them to take up positions of responsibility within their institute, at universities, in industry, and in society. Students who choose to work on projects at the Fraunhofer Institutes have excellent prospects of starting and developing a career in industry by virtue of the practical training and experience they have acquired.

The Fraunhofer-Gesellschaft is a recognized non-profit organization that takes its name from Joseph von Fraunhofer (1787–1826), the illustrious Munich researcher, inventor, and entrepreneur.

> www.fraunhofer.de/en.html

FRAUNHOFER INSTITUTE FOR MANUFACTURING TECHNOLOGY AND ADVANCED MATERIALS IFAM

1 Wiener Strasse 12
28359 Bremen, Germany

2 **Branch Dresden**
Winterbergstrasse 28
01277 Dresden, Germany

3 **Electrical Energy Storage**
Marie-Curie-Strasse 1–3
26129 Oldenburg, Germany

4 **Automation and Production Technology**
Forschungszentrum CFK NORD
Ottenbecker Damm 12
21684 Stade, Germany

5 **Fraunhofer Project Center Wolfsburg**
Elektromobility and Lightweight Construction
Hermann-Münch-Strasse 1
38440 Wolfsburg, Germany

6 **Fraunhofer Project Center for Energy Storage and Systems CES**
Braunschweig, Germany
Under construction

- Institutes and facilities
- Other locations

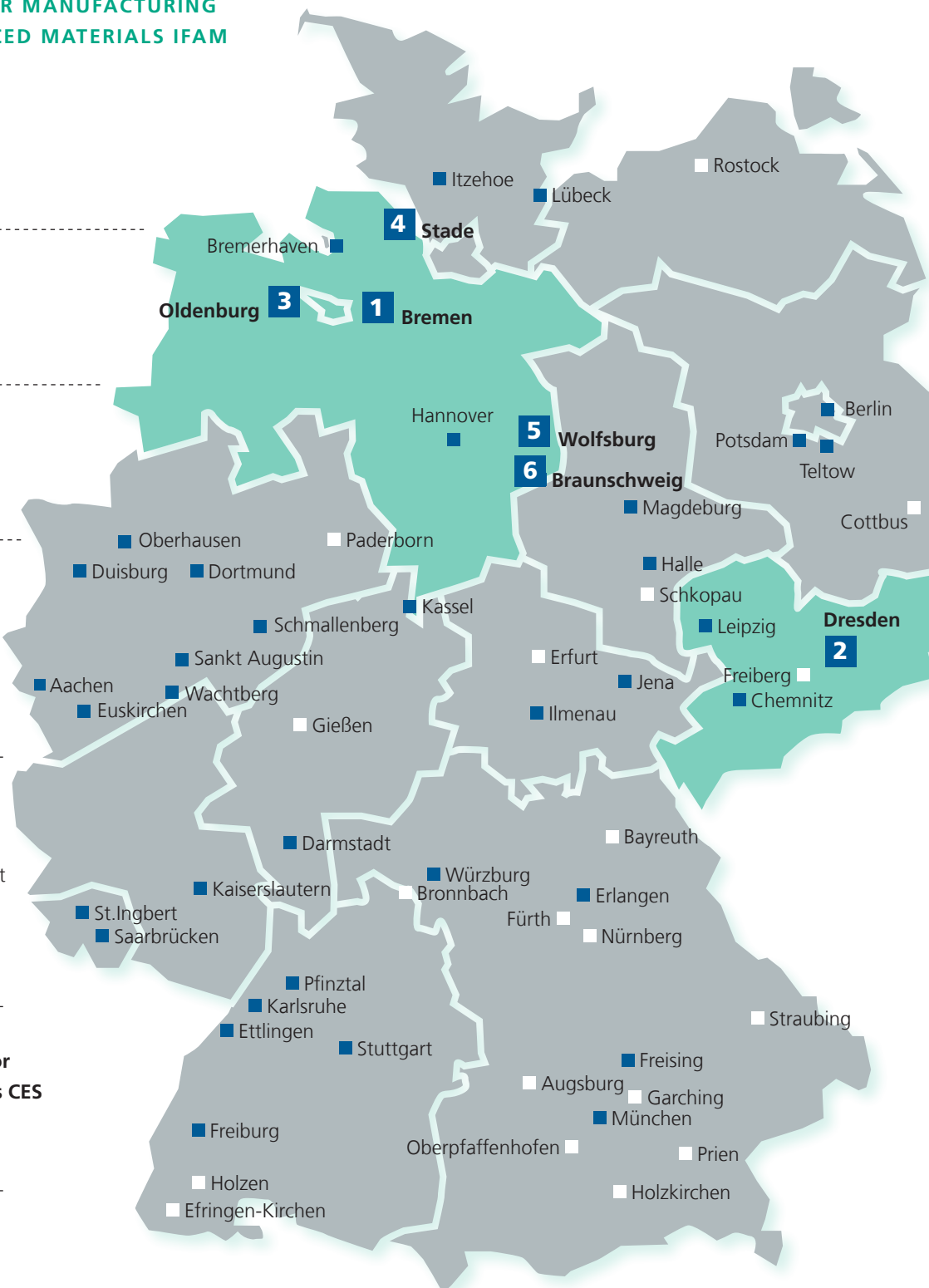

BRIEF PORTRAIT AND ORGANIGRAM

Founded in 1968 and integrated into the Fraunhofer-Gesellschaft in 1974, Fraunhofer IFAM is one of the most important research institutions in Europe for adhesive bonding technology, surfaces, shaping, and functional materials. At our institute's five locations – Bremen, Dresden, Oldenburg, Stade and Wolfsburg, as well as another future location in Braunschweig* – we put our central principles into practice: Scientific excellence, a focus on the application of technology, measurable utility for customers, and ensuring the highest quality. Our over 600 employees, working in 20 departments,

combine their broad technological and scientific knowledge and expertise into seven core competences: Metallic materials, polymeric materials, surface technology, adhesive bonding, shaping and functionalization, electromobility, and automation and digitalization. These core competences – both individually and in combination with each other – are the basis not only of our strong position in the research market but also of future-oriented developments that will be useful for society.

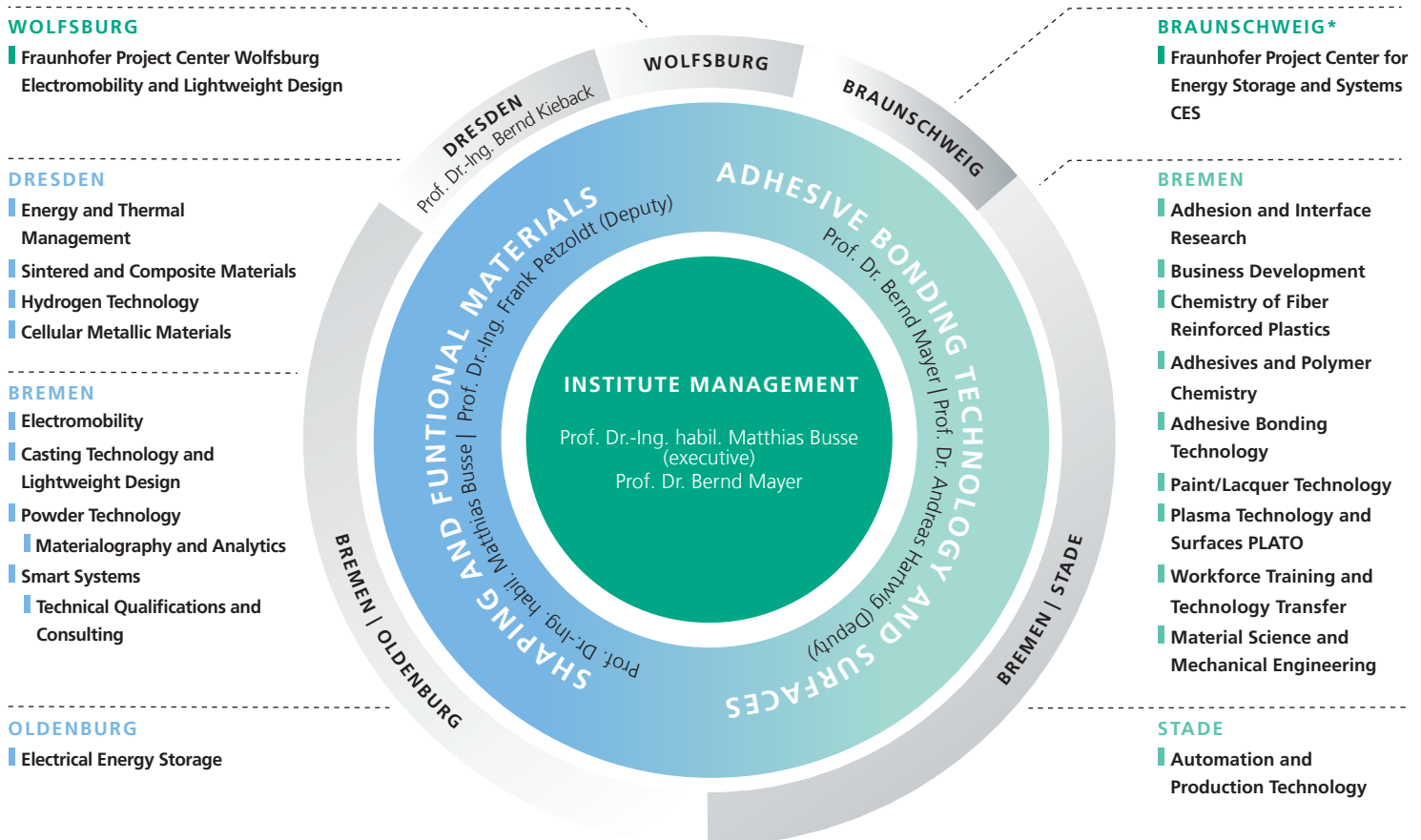

*Under construction

Operating and investment budget 2013–2017

Mio. €

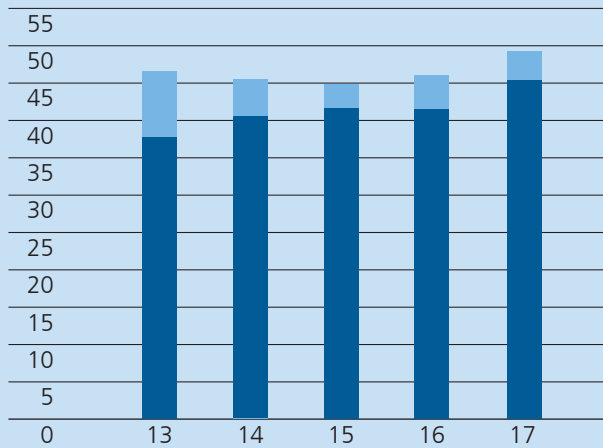

Operating budget	44,7 Mio. €
Investment budget	3,9 Mio. €

Project revenues 2013–2017

Mio. €

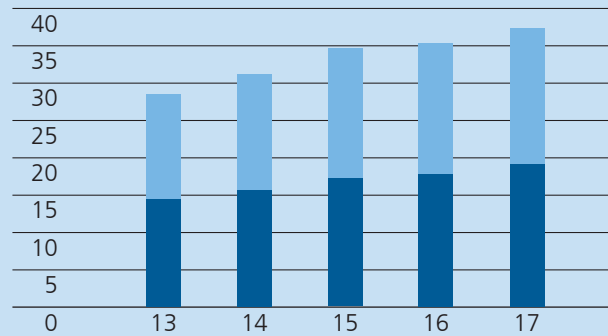

Industry	18,8 Mio. €
Federal/state/EU/other	17,9 Mio. €

Personnel development 2013–2017

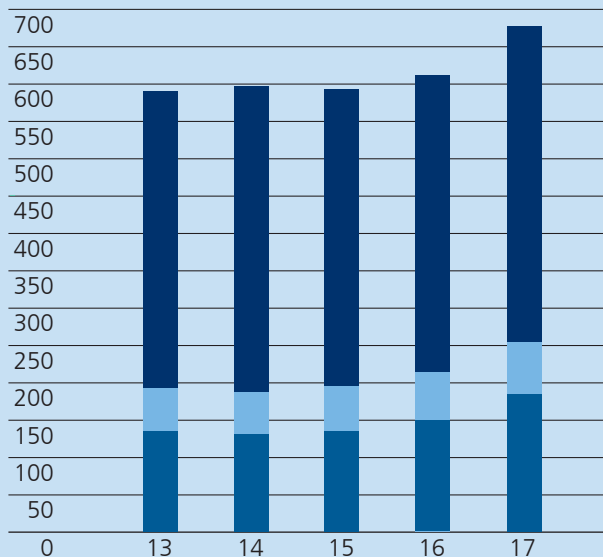

Personnel structure 2017

On December 31, 2017, a total of 668 staff were employed by Fraunhofer IFAM in Bremen, Dresden, Oldenburg, Stade, and Wolfsburg.

Scientific-technical staff	418
Administration/IT/Service	68
Student assistants/Students	182
total	668

Scientific-technical staff
Administration/IT/Service
Student assistants/Students

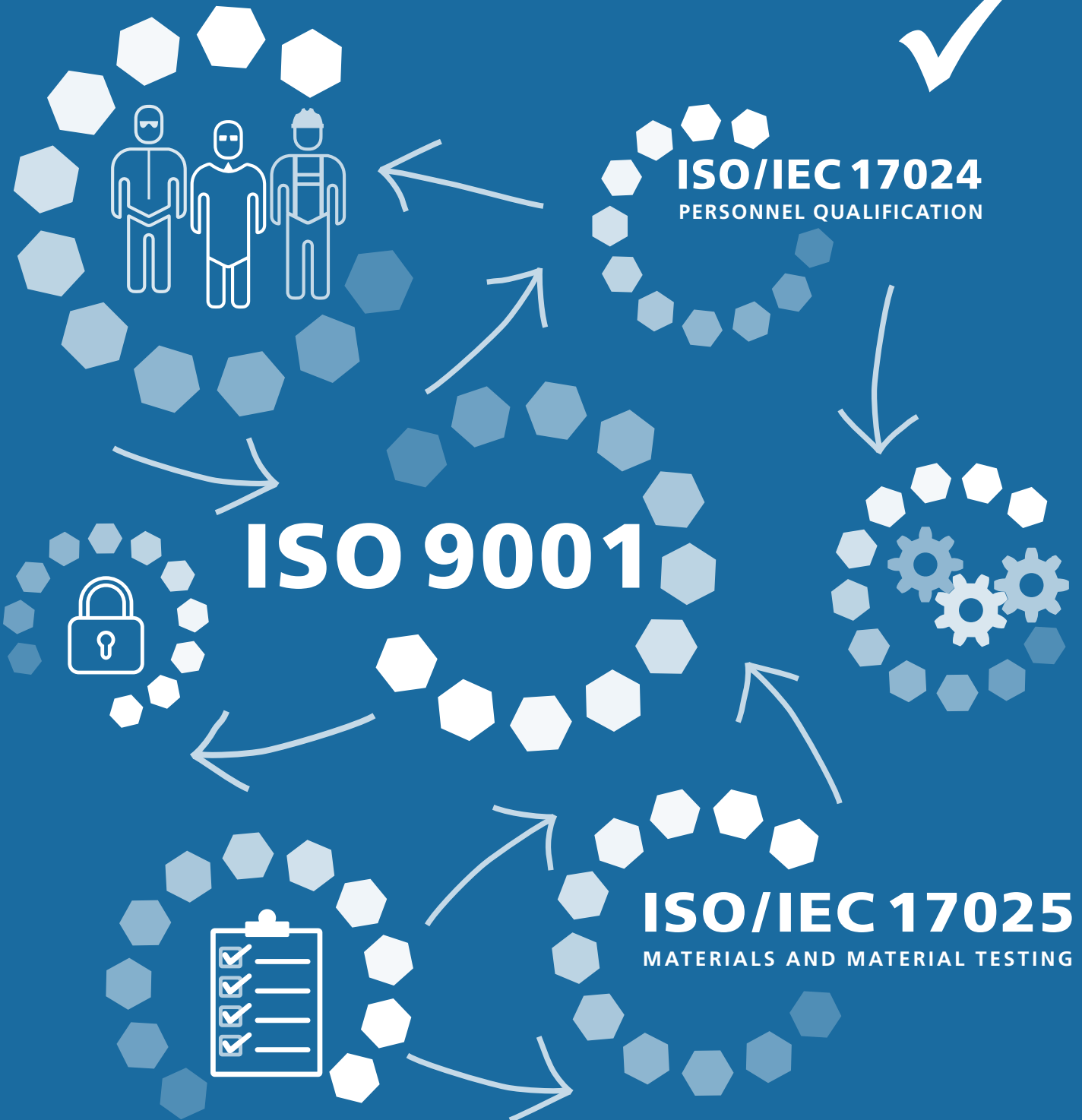

ISO/IEC 17024
PERSONNEL QUALIFICATION

ISO 9001

ISO/IEC 17025
MATERIALS AND MATERIAL TESTING

QUALITY MANAGEMENT

Certification according to DIN EN ISO 9001

Fraunhofer IFAM has been certified in accordance with DIN EN ISO 9001 since 1995. Certified services at Bremen and Stade include:

- Product-oriented development of materials, mechanical engineering, processes and production technologies for adhesive bonding technology, surface technology, and paint/lacquer technology
- Characterization and simulation of materials and their technologies
- Adhesive development
- Training courses in adhesive bonding technology, fiber reinforced plastics, and electromobility
- Casting technology
- Metallography, thermal analytics, powder measuring technology, and trace analysis
- Laboratories for material testing, paint/lacquer technology, corrosion testing, materialography, and analytics

Accreditation according to DIN EN ISO/IEC 17025

The testing laboratories for material testing, paint/lacquer technology, corrosion testing, materialography, and analytics in Bremen have also been DIN EN ISO/IEC 17025 accredited since 1996. Accreditation by the DAkkS (German Accreditation Body) is only valid for accreditations listed in the document appendix D-PL-11140-02-00.

At the Dresden branch of Fraunhofer IFAM, the testing laboratory is DIN EN ISO/IEC 17025-accredited for special testing of the characterization of inorganic powders and sintering materials as well as for material tests of metallic materials. Accreditation by the DAkkS is only valid for accreditations listed in the document appendix D-PL-11140-06-00.

Recognition according to DIN EN ISO/IEC 17024

The Adhesive Technology Center at the Education Center for Adhesive Bonding Technology is an internationally recognized training center for personnel qualification and has been approved by DIN EN ISO/IEC 17024 accredited DVS-PersZert® (German Welding Society, authorized National Body for Personnel Certification) since 1998.

PROFILE OF FRAUNHOFER IFAM



Forschen Forschen Forschen Forschen Forschen Forschen Forschen Forschen Forschen
Entwickeln Entwickeln Entwickeln Entwickeln Entwickeln Entwickeln Entwickeln Entwickeln
Anwenden Anwenden Anwenden Anwenden Anwenden Anwenden Anwenden Anwenden Anwenden

THE ADVISORY BOARD

Members

Dr. Rainer Rauh

Chair of the Advisory Board
Airbus Deutschland GmbH
Bremen

Prof. Dr. Andreas Breiter

University of Bremen
Bremen

Bernd Faller

RAMPF Production Systems
GmbH & Co. KG
Zimmern ob Rottweil

Michael Grau

Mankiewicz Gebr. & Co.
Hamburg

Dr. Jürgen Groß

Robert Bosch GmbH
Stuttgart

Dr. Sebastian Huster

Lower Saxony State Ministry
for Science and Culture
Hannover

Staatsrat

Gerd-Rüdiger Kück

Senator of Science, Health
and Consumer Protection of
the Free Hanseatic City of
Bremen
Bremen

Dr. Georg Oenbrink

Evonik Industries AG
Essen

Dr. Stefan Röber

tesa SE
Hamburg

Dr. André Walter

Airbus Operations GmbH
Bremen

Christoph Weiss

BEGO Bremer Goldschlägerei
Wilh. Herbst GmbH & Co. KG
Bremen

Guests

Dr. Heide Ahrens

Higher Education and
Research of the Senator of
Science, Health and Con-
sumer Protection of the Free
Hanseatic City of Bremen
Bremen

Ansgar van Halteren

Industrieverband
Klebstoffe e. V.
Düsseldorf

Dr. Mathias Kraas

Olympus Winter & Ibe GmbH
Hamburg

Werner Lotz

FFT Produktionssysteme
GmbH & Co. KG
Fulda

Dr. Christian Terfloth

Jowat AG
Detmold

Carsten Utikal

State Ministry of Science and
Cultural Affairs of Saxony
Dresden

BUSINESS SEGMENTS

Automotive

Automobile manufacturing is increasingly determined by the challenges of boosting innovation and quality while saving time and costs during production. Current development goals are electrification, environmental sustainability, energy efficiency, digitalization, and lightweight construction. Fraunhofer IFAM supports the automotive industry in transforming these challenges into a high technological standard.

Thanks to its comprehensive approach, Fraunhofer IFAM is the leading development partner for the realization of modern mixed construction methods through adhesive bonding and hybrid joining. Process development for the use of novel metallic and polymeric materials as well as the functionalization of surfaces and components are further competences.

Fraunhofer IFAM possesses a comprehensive understanding of systems in the field of electromobility and offers the automotive industry solutions for the electrification and hybridizing of the drive train as well as new concepts for batteries and mobility. Training courses and a high level of quality in the fields of adhesive bonding technology, fiber reinforced composites, and electromobility ensure the necessary technology transfer.

> www.ifam.fraunhofer.de/en/automotive

Energy technology

The business segment of energy technology addresses companies that make important contributions to a resource-efficient and stable energy supply through energy conversion (e.g., via combined heat and power systems and electrolysis), energy distribution, and energy storage.

The targeted efficiency increase in the use of electrical and thermal energy in buildings, transportation, and production is a constant challenge in many sectors. With its practical experience regarding materials and components that store hydrogen, electricity, and heat as well as the shaping process and coating technology, Fraunhofer IFAM offers multiple solutions for companies working in the energy, environment, and maritime technology sectors as well as in engineering and transportation.

> www.ifam.fraunhofer.de/energy

Aviation

The aviation business segment is aimed at manufacturers of aircraft and helicopters as well as the associated supply chain. The aviation industry is facing a number of challenges in the constant struggle to reduce fuel consumption, noise levels, and toxic emissions. New materials, lightweight construction technologies, and efficient engines are some of the answers to these issues.

Constant cost pressure is not only forcing these companies to find innovative ways to further automate their manufacturing processes, it is also leading them to develop new and more effective ways of reducing the MRO costs.

With its core competences, Fraunhofer IFAM offers companies in the aviation industry application-oriented solutions.

> www.ifam.fraunhofer.de/aviation

Maritime technologies

In the business segment maritime technologies, Fraunhofer IFAM is pooling its expertise from the key research points of coatings for corrosion and anti-fouling, functional surfaces, adhesive bonding production, and lightweight construction. The development processes are accompanied by analyses and quality control throughout the entire production chain. The electrification of ship propulsion and electrical energy storage systems for use both above and below the waterline are further goals.

In addition to the development activities in the technical center, Fraunhofer IFAM offers testing capabilities under realistic conditions. In List auf Sylt, at the "Alte Weser" lighthouse, and on the offshore island of Helgoland, hundreds of samples can be tested for their anti-corrosive and anti-fouling properties under constant submersion, in the tidal zone, in the splash zone, and on land.

> www.ifam.fraunhofer.de/maritime-technologies

Medical technology and life sciences

In the business segment of medical technology, Fraunhofer IFAM serves the interests of manufacturers of implants, instruments, medical adhesives, and coatings. In the life sciences division, functional materials and bio-surface engineering constitute the focus of research.

In addition to materials and coatings, Fraunhofer IFAM also develops manufacturing processes so that the required product performance and effectiveness are achieved, while at the same time meeting the high quality demands of the sector.

During the development of the materials and surfaces, the normative and technical demands, such as biocompatibility and degradation behavior as well as the chemical, physical, mechanical, and morphological characterization are considered and implemented right from the start.

> www.ifam.fraunhofer.de/medicine

PROFILE OF FRAUNHOFER IFAM



FIELDS OF ACTIVITY AND CONTACTS

INSTITUTE DIRECTORS

- Prof. Dr.-Ing. habil. Matthias Busse (executive)
- Prof. Dr. Bernd Mayer

SHAPING AND FUNCTIONAL MATERIALS DIVISION

- Prof. Dr.-Ing. habil. Matthias Busse
Phone +49 421 2246-100
matthias.busse@ifam.fraunhofer.de

DRESDEN BRANCH

- Prof. Dr.-Ing. Bernd Kieback
Phone +49 351 2537-300
bernd.kieback@ifam-dd.fraunhofer.de

ADHESIVE BONDING TECHNOLOGY AND SURFACES DIVISION

- Prof. Dr. Bernd Mayer
Phone +49 421 2246-401
bernd.mayer@ifam.fraunhofer.de

HEAD OF ADMINISTRATION

- Oliver A. Dreher
Phone +49 421 2246-333
oliver.dreher@ifam.fraunhofer.de

LOCATIONS

OLDENBURG

- Dr. Julian Schwenzel
Phone +49 441 36116-262
julian.schwenzel@ifam.fraunhofer.de

STADE

- Dr. Dirk Niermann
Phone +49 4141 78707-101
dirk.niermann@ifam.fraunhofer.de

WOLFSBURG

- Dr.-Ing. Torben Seemann
Phone +49 421 2246-126
torben.seemann@ifam.fraunhofer.de

BRAUNSCHWEIG*

- Dr. Julian Schwenzel
Phone +49 441 36116-262
julian.schwenzel@ifam.fraunhofer.de

ADHESION AND INTERFACE RESEARCH

Dr. Stefan Dieckhoff

Phone +49 421 2246-469

stefan.dieckhoff@ifam.fraunhofer.de

> www.ifam.fraunhofer.de/interface

- Surface and nanostructure analysis
 - Corrosion protection and electrochemistry
 - Computer-aided material simulation
 - Quality assurance – monitoring surface and bond properties
 - Development of customer-specific inspection procedures
 - Physico-chemical analysis of interface and material properties
 - Wet chemical pre-treatment of surfaces
 - Accredited corrosion testing laboratory
 - Failure analysis
-

AUTOMATION AND PRODUCTION TECHNOLOGY

Dr. Dirk Niermann

Phone +49 4141 78707-101

dirk.niermann@ifam.fraunhofer.de

> www.ifam.fraunhofer.de/en/stade

- Automated assembly of large structures up to a 1:1 scale
 - Sensor-controlled, mobile robots with high positioning accuracy
 - Joining techniques (adhesives, shims, sealants)
 - Processing technologies (milling, drilling, water jet cutting)
 - Automated component handling
 - Shape and positional correction for large components
 - Release agent free production of fiber composite components
 - Manufacture of prototype components and structures
 - Development of plants and components
-

BUSINESS DEVELOPMENT

Prof. Dr. Bernd Mayer

Phone +49 421 2246-401

bernd.mayer@ifam.fraunhofer.de

> www.ifam.fraunhofer.de/netzwerker

- Contact for European research projects, including project conception and applications
 - Participation in regional, national, and international industry networks
 - Coordination of major projects
 - Contact for large companies
-

CHEMISTRY OF FIBER REINFORCED PLASTICS

Dr. Katharina Koschek
 Phone +49 421 2246-698
 katharina.koschek@ifam.fraunhofer.de
 > www.ifam.fraunhofer.de/en/durocycle

- Controlled polymerization reactions
- Novel matrix systems for fiber reinforced plastics
- Reversible reactions
- Development of switchable, multifunctional polymers
- Bio-based fiber reinforced plastics

ENERGY AND THERMAL MANAGEMENT

Prof. Dr.-Ing. Jens Meinert
 Phone +49 152 56608698
 jens.meinert@ifam-dd.fraunhofer.de
 > www.ifam.fraunhofer.de/en/etm

- Efficient storage of heat and cold
- Development of high-performance latent heat storage
- Optimization of heat transport operations
- Cellular metals in compact heat exchanges
- Structuring of evaporator surfaces
- Thermal management – heat generating components
- Mold temperature control
- Mathematical modelling of heat transport
- Simulation of melting and solidification processes
- Measurement of material and transport temperatures

ELECTROMOBILITY

Dipl.-Ing. Felix Horch
 Phone +49 421 2246-171
 felix.horch@ifam.fraunhofer.de
 > www.ifam.fraunhofer.de/en/emob

- Development, design, and simulation of electrical drive systems
- Development of control systems, control units, and software
- Testing of components and electrical drive analysis
- Feasibility studies and consultation on:
 - Energy supply, climate protection
 - Energy efficient buildings and districts
 - Combined heat and power systems
 - Battery cell chemistry
 - Paste development and electrode manufacture
 - Cell construction and design for lithium-ion, metal-air, and solid-state batteries

FRAUNHOFER PROJECT CENTER WOLFSBURG ELECTROMOBILITY AND LIGHTWEIGHT CONSTRUCTION

Dr.-Ing. Torben Seemann
 Phone +49 421 2246-126
 torben.seemann@ifam.fraunhofer.de
 > www.ifam.fraunhofer.de/en/wolfsburg

- Lightweight automotive design with integrated functions
- Manufacturing chain
- Hybrid metals with a metallic mix
- Matrix components for electrical vehicles

FRAUNHOFER PROJECT CENTER FOR ENERGY STORAGE AND SYSTEMS CES

Dr.-Ing. Julian Schwenzel
Phone +49 441 36116-262
julian.schwenzel@ifam.fraunhofer.de

- Solid-state-lithium batteries for electromobility
- System development for stationary sodium batteries
- System development for power-to-X systems and hydrogen systems
- Non-destructive test processes for the manufacture of storage facilities and their operations
- Innovative production processes for storage facilities

CASTING TECHNOLOGY AND LIGHTWEIGHT CONSTRUCTION

Dipl.-Ing. Franz-Josef Wöstmann MBA
Phone +49 421 2246-225
franz-josef.woestmann@ifam.fraunhofer.de
> www.ifam.fraunhofer.de/casting

- Cold and warm chamber pressure casting (aluminum, magnesium, zinc)
- Lost foam casting
- Low pressure casting (aluminum, copper, iron, steel, salts)
- Investment casting
- Development of core materials (salt cores, lost cores, complex geometries)
- Functional integration/CAST^{TRONICS}®
- Component identification (individual identification as the basis for Industry 4.0)
- Composite casting/hybrid casting (hybrids made of metal and fiber materials)
- Topology optimization/lightweight construction

ADHESIVES AND POLYMER CHEMISTRY

Prof. Dr. Andreas Hartwig
Phone +49 421 2246-470
andreas.hartwig@ifam.fraunhofer.de
> www.ifam.fraunhofer.de/adhesives

- Formulation of adhesives
- Matrix resins for fiber reinforced plastics
- Characterization of adhesives/bonded joints
- Novel additives, polymers, and other raw materials
- Morphology of adhesives and other thermosets, e.g. nanocomposites
- Bio-functional surfaces and bioanalysis
- Adhesives based on sustainable raw materials
- Adhesives for medicine and medical technology
- Improved reliability and productivity of bonding processes
- Market consulting for adhesives and related raw materials

ADHESIVE BONDING TECHNOLOGY

Dr. Holger Fricke

Phone +49 421 2246-637

holger.fricke@ifam.fraunhofer.de

> www.ifam.fraunhofer.de/abt

- Industrial adhesive manufacturing processes
- Selection and characterization of adhesives and sealants as well as casting compounds
- Production planning, simulation, process design and automation
- Dosing, mixing, and application technologies
- Production of bonded prototypes
- Consultation and auditing of industrial bonding
- Bonding in the microsystem technology (electrical/optical)
- Coating of sheet materials (adhesives, lacquers, functional materials)

PLASMA TECHNOLOGY AND SURFACES PLATO

Dr. Ralph Wilken

Phone +49 421 2246-448

ralph.wilken@ifam.fraunhofer.de

> www.ifam.fraunhofer.de/en/plato

- Low pressure plasma technology
- Atmospheric pressure plasma technology
- VUV excimer technology
- Laser technology
- Plant technology and construction
- New surface technologies
- CVD processes
- Tribology
- Functional coatings
- Sheet materials/film technologies
- Pre-treatment, cleaning, activation

PAINT/LACQUER TECHNOLOGY

Dr. Volkmar Stenzel

Phone +49 421 2246-407

volkmar.stenzel@ifam.fraunhofer.de

> www.ifam.fraunhofer.de/paint

- Processing and application technologies for paints and coatings
- Qualification of materials and processes
- Functional paints and coatings (e.g. anti-ice paints anti-fouling coatings, self-healing and dirt repelling coatings, electrically insulating layers)
- Analysis of raw materials for coatings
- Coating formulation
- Test methods
- Analysis of damage/failure

POWDER TECHNOLOGY

Prof. Dr.-Ing. Frank Petzoldt

Phone +49 421 2246-134

frank.petzoldt@ifam.fraunhofer.de

> www.ifam.fraunhofer.de/en/pt

- Powder injection molding
- Additive manufacturing (SLM, binder-based processes)
- Pressing and sintering
- Magnetic materials
- Composite materials
- Metal foams
- Analysis (powder analysis, thermo-analysis)
- Metallography
- Damage appraisals

SINTERED AND COMPOSITE MATERIALS

Dr.-Ing. Thomas Weißgärber

Phone +49 351 2537-305

thomas.weissgaerber@ifam-dd.fraunhofer.de

> www.ifam.fraunhofer.de/scm

- Powder metallurgical technologies, rapid solidification
- Additive manufacturing (electron beam melting technology, dispensing technology)
- Composite materials, multi-material composites
- Dispersion strengthened materials
- Light metals
- Materials for tribological applications and their testing
- Materials for energy conversion (thermoelectric) and storage (supercaps)
- High temperature materials and their testing
- Sputter targets
- Thermoanalytical processes

HYDROGEN TECHNOLOGY

Dr. Lars Röntzsch

Phone +49 351 2537-411

lars.roentzsch@ifam-dd.fraunhofer.de

> www.ifam.fraunhofer.de/en/h2

- Electrode materials and catalysts for water electrolysis
- Electrochemical characterization of electrodes
- Development and testing of electrolysis cells
- Metal hybrids for reversible H₂ storage, H₂ cleaning, and H₂/D₂ isotope separation
- Techniques for the production of metal hybrids
- Development and testing of hybrid reactors
- Integration of hybrid reactors in H₂ energy systems
- Hydrolysis reactions for H₂ generation for H₂-on-demand solutions
- Hydrogen of powder manufacture
- Recycling technologies for rare earth materials (magnets, production waste, etc.)
- Comprehensive analysis of H₂-solid reactions

SMART SYSTEMS

Dr. Volker Zöllmer

Phone +49 421 2246-114

volker.zoellmer@ifam.fraunhofer.de

> www.ifam.fraunhofer.de/en/smartsystems

- Printed electronics and 3D printing
- Sensor integration
- Printable inks and pastes
- (Nano-) composites and functional materials
- Test stand for electrical storage systems
- Test field for electrical energy system components
- Data logging and evaluation
- Technical training in electromobility
- Knowledge and technology transfer

WORKFORCE TRAINING AND TECHNOLOGY TRANSFER

Prof. Dr. Andreas Groß
 Phone +49 421 2246-437
 andreas.gross@ifam.fraunhofer.de
 > www.bremen-bonding.com
 > www.bremen-composites.com

- Training courses in adhesive bonding technology
- Training courses in fiber composite technology
- Quality assurance for adhesive bonding technology
- Quality assurance for fiber composite technology
- Promotion of young scientists and engineers (MINT)

MATERIALS SCIENCE AND MECHANICAL ENGINEERING

Dr. Markus Brede
 Phone +49 421 2246-476
 markus.brede@ifam.fraunhofer.de
 > www.ifam.fraunhofer.de/materialscience

- Testing of materials and components
- Verification and measurement of adhesively bonded structures
- Bonded and riveted joints: design, sizing, crash/fatigue behavior
- Combination and optimization of mechanical joining processes
- Qualification of mechanical fasteners
- Fiber composite components, lightweight and hybrid constructions
- Accredited material testing laboratory

CELLULAR METALLIC MATERIALS

Dr.-Ing. Olaf Andersen
 Phone +49 351 2537-319
 olaf.andersen@ifam-dd.fraunhofer.de
 > www.ifam.fraunhofer.de/cmm

- Cellular metals made from various special materials
- Additive component manufacture with 3D screen and filament printing
- Open cell fiber structures, foams, and films
- Hollow sphere structures and precision hollow spheres
- Reinforcement of cast components with 3D wire structures
- High performance vibration damping
- High performance heat storage systems
- Degradable metallic implant materials
- Jewelry and design
- Catalysis and filtration
- Functional surface coatings with polymer-derived ceramics
- Optimization of debinding processes through in situ gas analysis

PROFILE OF FRAUNHOFER IFAM

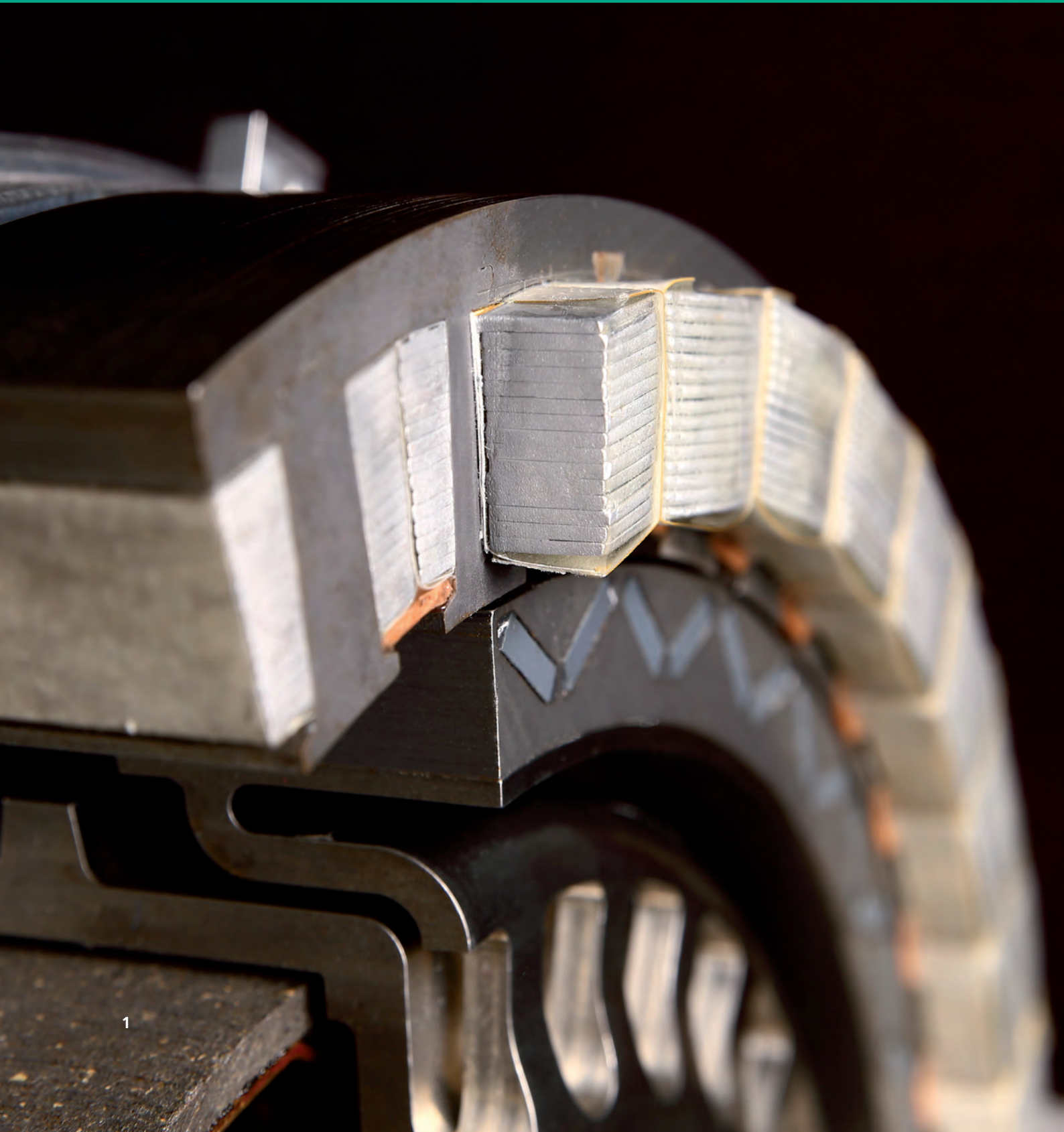

SHAPING AND FUNCTIONAL MATERIALS

To successfully work on complex system solutions requires a functioning network of partners in industry and science, where know-how and methodical skills are particularly important, – especially at the interface between different areas of expertise. The know-how of Fraunhofer IFAM's personnel and our network of partners from industry and science put us in an excellent position to develop innovative solutions for the benefit of the industry.

Transforming basic, application-oriented research into industrially viable solutions or component-specific developments requires us to continually expand our knowledge base and methodological competence. This is why the continuous expansion of our specific skills and know-how is given high priority by the Shaping and Functional Materials division at Fraunhofer IFAM.

One key area of work concerns state-of-the-art powder-based production processes, such as metal injection molding and additive manufacturing. These processes are being increasingly used by the industry to manufacture components with complex shapes from various metal alloys. Especially for additive manufacturing, Fraunhofer IFAM possesses a wide range of equipment for binder-free processes, such as selective laser melting and electron beam melting, as well as for binder-based 3D printing. The qualification of the powders used in additive manufacturing is driven with state-of-the-art measurement and analysis techniques. The institute's technical center is to be expanded and more equipment added to allow the qualification of additive manufacturing technologies also for aviation and aerospace applications.

Multifunctional components with integrated sensor functions make specific demands on the materials that are being used. Combining various materials in a single component allows a

localized customization of properties. Designing these material combinations and controlling the required production process are key aspects of our R&D activities. The range of material combinations includes metal-metal and metal-ceramic as well as combinations with fiber composite materials.

In the area of "functional printing", we are working on formulas for functional inks and pastes and how to apply them to components. This allows components to be equipped with sensors in order to acquire information, e.g. on the operating and environmental conditions. Our robot-based production line for the functionalization of components and surfaces represents a further key step in introducing sensor integration via printing techniques into automated industrial production processes.

- 1 *In the construction of a wheel hub drive, the cast aluminum springs developed at Fraunhofer IFAM are inserted into the drive with a maximum slot fill factor.*
- 2 *Highly conductive composite filament for 3D printing.*

State-of-the-art casting equipment, analytical facilities, and in-depth know-how regarding the casting of metal alloys using various processes place Fraunhofer IFAM in an excellent position to serve the future needs of the industry. The technical center for casting includes equipment for high-pressure die casting, low-pressure die casting, investment casting, and – unique in Europe – a complete lost foam unit.

For the use of cellular metallic materials in modern products, we are developing customized solutions for different applications and are continually expanding our process knowledge. Our R&D portfolio is constantly being adjusted to meet the needs of the market and to identify new technological challenges. Such issues as product innovation under strict commercial conditions are just as important as the contribution of our R&D results to improving the quality of life and to ensuring sustainable developments in the area of transport, energy, medicine, and the environment. Material properties and technologies for structural and functional applications are being customized and characterized. To this end, high-performance materials, composite materials, gradient materials, and smart materials are being advanced and improved, as are production technologies for the integration of properties into components.

Our ever-increasing expertise in special functional materials, such as magnets, thermal management materials, thermoelectric and magnetocaloric materials, and nanocomposites is opening up new opportunities for the development of our customers' products.

Regarding the development, assembly, and testing of components for electric vehicles and their integration into systems, the services of Fraunhofer IFAM cover the customized testing and evaluation of electric motors, power converters, control systems, and traction batteries. For example, studies are carried out on battery aging and the characterization of the endurance properties of electric drive systems using standardized and real driving cycles. The development and testing of novel

hydrogen storage systems and their integration into fuel cell based energy and drive systems complete our range of work.

In the area of electrical energy storage, focus is increasingly moving from lithium-ion and metal-air batteries to solid-state batteries, which use ion-conducting ceramics, polymers, or composites instead of liquid electrolytes and have decisive advantages with regard to safety and energy density. This is where Fraunhofer IFAM's competence in the materials and manufacturing technology necessary for the material and process development comes into its own.

In addition, the topics of renewable energy, energy-efficient buildings, and grid-bound energy supply, particularly combined heat and power systems and energy storage, are addressed. An inter-divisional element of this concept is the analysis and evaluation of the cost effectiveness of complex systems – including the integration of electric vehicles as mobile energy storage units.

We are constantly expanding our range of seminars, technical training and consultation services on the subjects of electromobility, additive manufacturing, functional printing, and casting technology, each specially tailored to meet the individual needs of our customers.

Perspectives

In the Fraunhofer lighthouse project "Go Beyond 4.0" under the leadership of Fraunhofer ENAS, Fraunhofer IFAM and four other institutes are working on ways to individualize mass-produced products by integrating printing technology and laser processing into the production process. Based on three market-relevant applications from automobile manufacturing, aviation, and lighting technology, new manufacturing strategies and process innovations are being developed. Digital print and

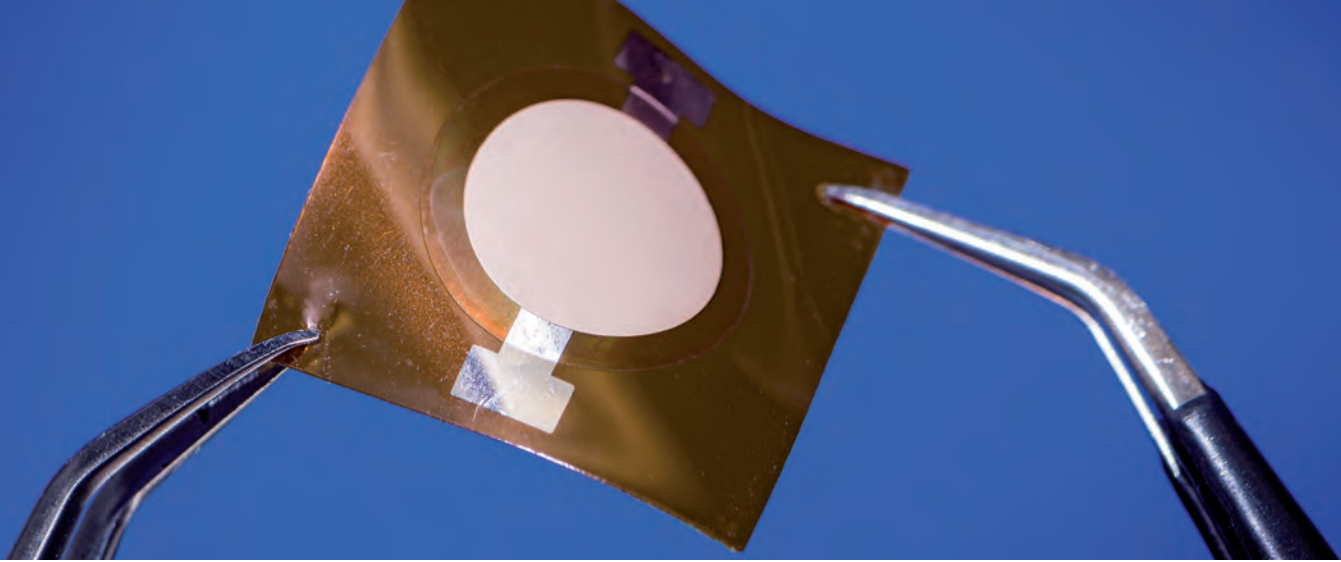

laser processes will be integrated into existing process chains as needed. Through the integration of sensors, actuators, or LEDs, the specification of products down to a batch size of one is possible.

As part of the “HARVEST” project of the Fraunhofer Zukunftsstiftung, work is being undertaken in collaboration with Fraunhofer ISE on the development and optimization of metallic heat transfer structures based on cellular metallic materials and metallic fiber structures. In a second project for the Fraunhofer Zukunftsstiftung “IFEM”, Fraunhofer IFAM and Fraunhofer IWU are collaborating on the large-scale industrial manufacture of cast or formed coils.

In the focus project “futureAM”, Fraunhofer IFAM is collaborating with five other Fraunhofer Institutes to develop new digital process chains, scalable and robust additive manufacturing processes, as well as system technology and automation and, last but not least, to expand the range of workable and affordable materials.

Together with the research and industry network for magnetocaloric systems, Fraunhofer IFAM is participating in multiple projects for the manufacturing of demonstrators.

Key areas of work

- Development and modification of materials: metallic materials, structural materials, functional materials, composite materials, cellular materials, thermal management, thermoelectric systems, composite materials, and magnetic materials
- Powder-metallurgical technologies: special sinter processes, metal injection molding, additive manufacturing processes
- Casting technologies: die casting, investment casting, lost foam casting
- Functionalization of components: sensors, actuators, nanostructuring, and microstructuring
- Material analysis and materialography
- Development and construction of electrical components and their integration into systems, testing components for the drive trains of electrical motors
- Material and process development for novel energy storage systems: nanostructured electrodes, manufacture of cell components, battery testing technology, and electrochemical analysis
- Hydrogen technology
- Testing and evaluating charging infrastructure for electromobility, training courses/technical seminars – national and international
- Energy-efficient buildings, heating networks, and electricity grids
- Combined heat and power systems

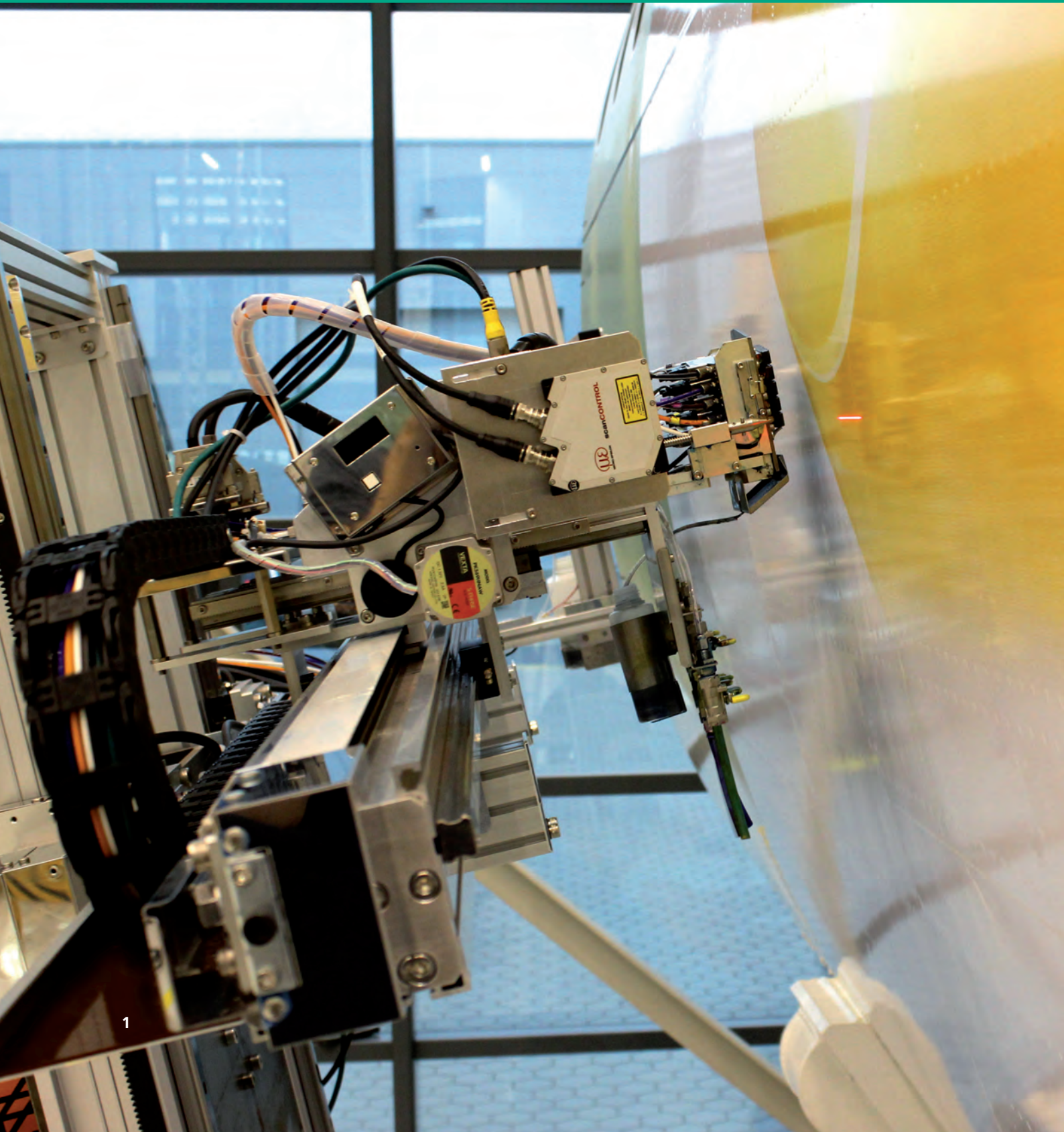

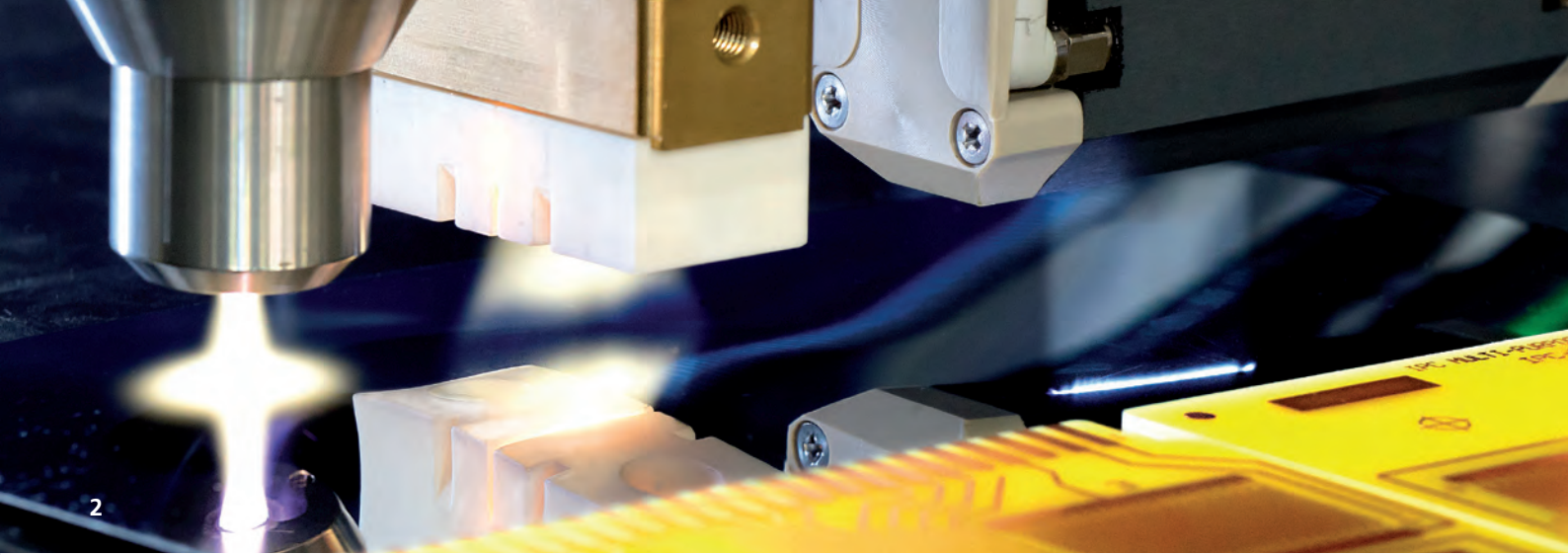

ADHESIVE BONDING TECHNOLOGY AND SURFACES

The Adhesive Bonding Technology and Surfaces division at the Fraunhofer Institute for Manufacturing Technology and Advanced Materials IFAM has more than 300 employees and is the largest independent research group working in the area of industrial adhesive bonding technology. Its key focus is in the fields of application-oriented R&D activities related to polymer materials, adhesive bonding, and surface technology as well as to automation and digitalization. The main goal is the development of system solutions for industrial applications.

The continuously changing demands of the cooperation partners constantly require new and sophisticated developments in the field of materials and joining processes. The research activities of the division range from application oriented basic research, industrial research, and experimental development to the implementation of the results in manufacturing and the continuing support during the market introduction of new products in cooperation with our partners. New process layouts and testing methods are furthermore brought in line with national European standardization processes. New findings are published in internationally established trade or peer-reviewed journals. Industrial fields of application are primarily the transportation sector – manufactures of aircraft, cars, trains, and ships – and their suppliers as well as energy technology, the construction, packaging, textile, and electronics industries, and finally microsystems and medical technology.

The core competence "polymer materials" includes the formulation and application-oriented characterization of adhesives, coatings, and casting compounds as well as the entire field of composite materials, including fiber reinforced plastics. The key focus is on reactive polymers and their technologies. This also includes the synthesis and characterization of new raw materials such as monomers, curing catalysts, or fillers. This is complemented through training opportunities offered in the field of fiber composite technology.

The material-related work represents an important base for the core competence "adhesive bonding", which comprises the selection, characterization, and verification of adhesives, the demand-appropriate constructive design and simulation of adhesive and hybrid joints as well as planning and automation in the industrial manufacture of adhesive bonds in addition to process reviews. The profile is rounded off with an inter-organizational, internationally recognized, and certifying range of training programs targeted at companies that use adhesive bonding technology. The division furthermore provides auditing for the evaluation of companies for certification in the manufacture of adhesive bonds on rail vehicles and parts of rail vehicles according to DIN 6701.

The core competence "surface technology" involves dry and wet chemical surface handling processes as well as the comprehensive characterization and qualification of surfaces. Key focus lies on plasma technology, coating technology, electrochemical processes, and the development of online and inline surface characterization processes for the industry.

- 1 *Novel coating concepts and decoration through digital printing in aircraft manufacture.*
- 2 *Needs-based surface treatment using atmospheric pressure plasma sources.*

Customized surface modifications through pre-treatments and functional coatings significantly expand the industrial use of many materials, or indeed make their technical use possible in the first place. The optimization of long-term durability, including the early detection of degradation and corrosion processes, as well as the validation of aging tests are emphasized. The research into aging and surface pre-treatments is highly relevant for both adhesive technology and coating – making adhesive bonds and coatings even more reliable.

Within the framework of the core competence "automation and digitalization", the automated assembly of large structures is a key focus. This includes work on the automated testing of components, robot-led surface pre-treatment, and the use of application-suited adhesives, extending to the development of mobile robot systems that are significantly more flexible and yet more precise than conventional industrial robots. In parallel, aspects of digitalization are being driven forward, for example for the characterization of surfaces for industrial quality assurance.

The entire Adhesive Bonding and Surfaces division is certified according to DIN EN ISO 9001, while the testing laboratories for material testing, corrosion testing, and coating technology are additionally DIN EN ISO/IEC 17025 accredited. The Training Center for Adhesive Bonding Technology is internationally recognized by DVS-PersZert® as a DIN EN ISO/IEV 17024 accredited personnel qualification location for further training in adhesive bonding technology. Furthermore, the Training Center for Fiber Composite Technology fulfills the quality demands of DIN EN/ISO/IEC 17024.

Perspectives

For the introduction of new technologies, the industry places high demands on process reliability, which are both standard and trendsetting for the R&D activities in the Adhesive Bonding and Surfaces division. Innovative products are developed in collaboration with the customer, who then successfully establishes them on the market. Manufacturing technologies are playing an increasingly important role here, as a high level of process quality and reproducibility are essential requirements for market success.

Although adhesive bonding technology is a long-established technology, for example in automobile manufacture, its potential is far from being fully realized. Adhesive bonding in medicine and medical technology, the aviation and aerospace industry, and civil engineering are just a few examples of potential areas for growth. In order to gain access to new sectors, the following is paramount in research activities: Adhesive bonding manufacture and bonded products must become even safer and more reliable! This goal can only be achieved through a holistic consideration of all steps in adhesive bonding manufacture. The new standard DIN 2304, which outlines the quality demands made on the adhesive bonding process, will provide fresh impulses for this technology. The implementation of this standard in the industry is becoming an essential focus of the research activities of this division.

The Adhesive Bonding and Surfaces division is increasingly using computer-assisted development methods. Examples range from the numerical description of flow processes in dosing pumps and valves and the multi-scale simulation of molecular dynamics to macroscopic finite element methods for the numerical description of materials and components. In addition, topics of digitalization are intensively being driven forward in areas such as surface characterization and automated assembly processes.

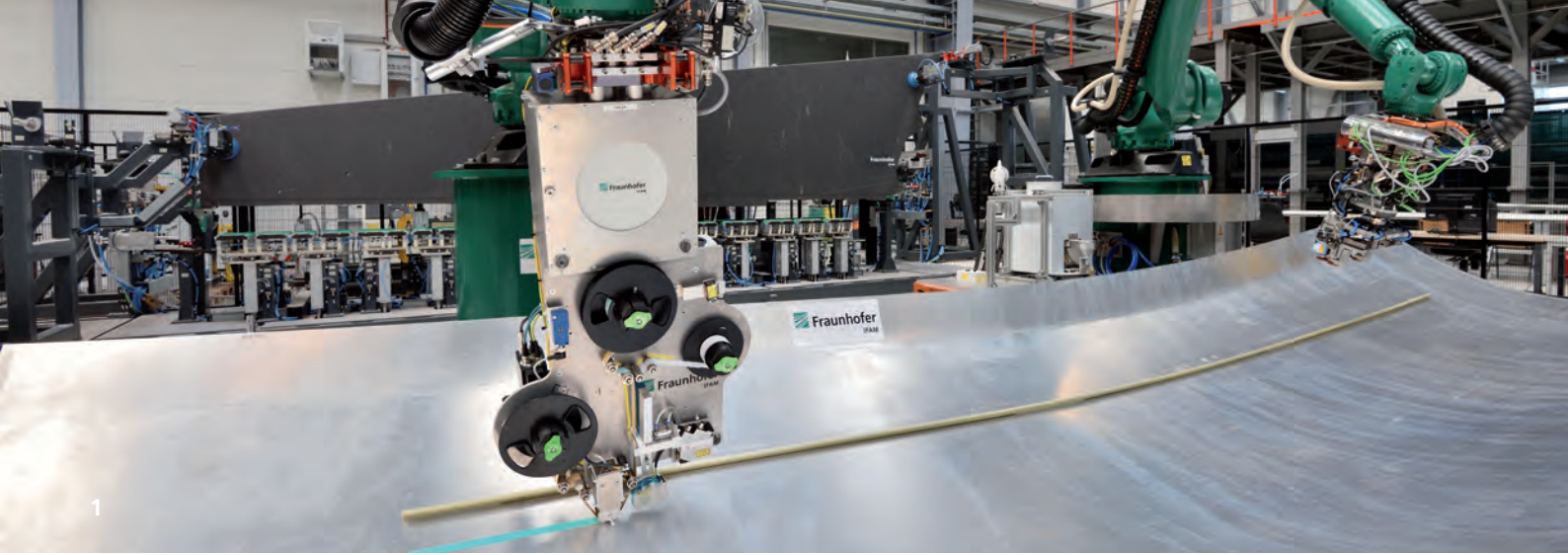

Various spectroscopic, microscopic, and electrochemical methods provide insight into the degradation and corrosion of material composites. Tailor made analyses and accompanying simulations enable results that could not be obtained through empirical testing based on standardized aging and corrosion tests. Sectors with high demands on surface and joining technologies make use of the high level of expertise offered by the institute; this is especially the case for long-living consumer goods, where intense demands are placed on their long-term resistance.

Key areas of work

- New polymers for adhesives, matrix resins for fiber composite materials, casting resins, and coatings
- Synthesis, formulation, and testing
- Development of additives (nanofillers, initiators, etc.) for reactive polymers
- Material models for polymer materials
- Training courses for Fiber Reinforced Plastic (FRP) Manufacturer, Fiber Reinforced Plastic (FRP) Remanufacturer, and Fiber Reinforced Plastic (FRP) Specialist as well as training modules for Fraunhofer Composite Engineer
- Innovative joining concepts through adhesive bonding and hybrid joining
- Selection and qualification of adhesives
- Biomimetic concepts in adhesive bonding and surface technology
- Development and qualification of adhesive bonding manufacturing processes; computer-aided manufacturing planning
- Application of adhesives/sealants, casting compounds (mixing, dosing, application)
- Design of bonded structures (simulation of the mechanical behavior of bonded joints and components using finite element methods, prototype construction)
- Parameter determination, vibration resistance, and operational stability of bonded joints
- Training courses – national and international – for European Adhesive Bonder (EAB), European Adhesive Specialist (EAS), and European Adhesive Engineer (EAE) as well as courses tailored to client needs and technology
- Upscaling of new joining processes as well as prototyping
- New methods for the modification and coating of surfaces
- Development of environmentally friendly pre-treatment processes and corrosion protection systems for plastics and metals
- Functional coatings through dry and wet chemical processes as well as functional lacquer systems
- Plasma processes for surface treatment, including the design of manufacturing facilities
- Development of special test methods (e.g. for the formation and adhesion of ice to surfaces, aging resistance)
- Evaluation of aging and degradation processes in material composites, electrochemical analysis
- Material development with quantum/molecular mechanical methods
- Automation, parallelization, and digitalization of processes
- Robot-supported assembly of large structures
- Processing of fiber reinforced composites
- Mobile robot systems in cooperation with human workers
- Software development for surface control technology, automated assembly, and feedback control
- Quality assurance concepts for applications in adhesive and paint/lacquer technology through manufacturing-integrated and digital analyses of component surfaces

1 *Stringer placement by cooperating robots.*

METALLIC MATERIALS

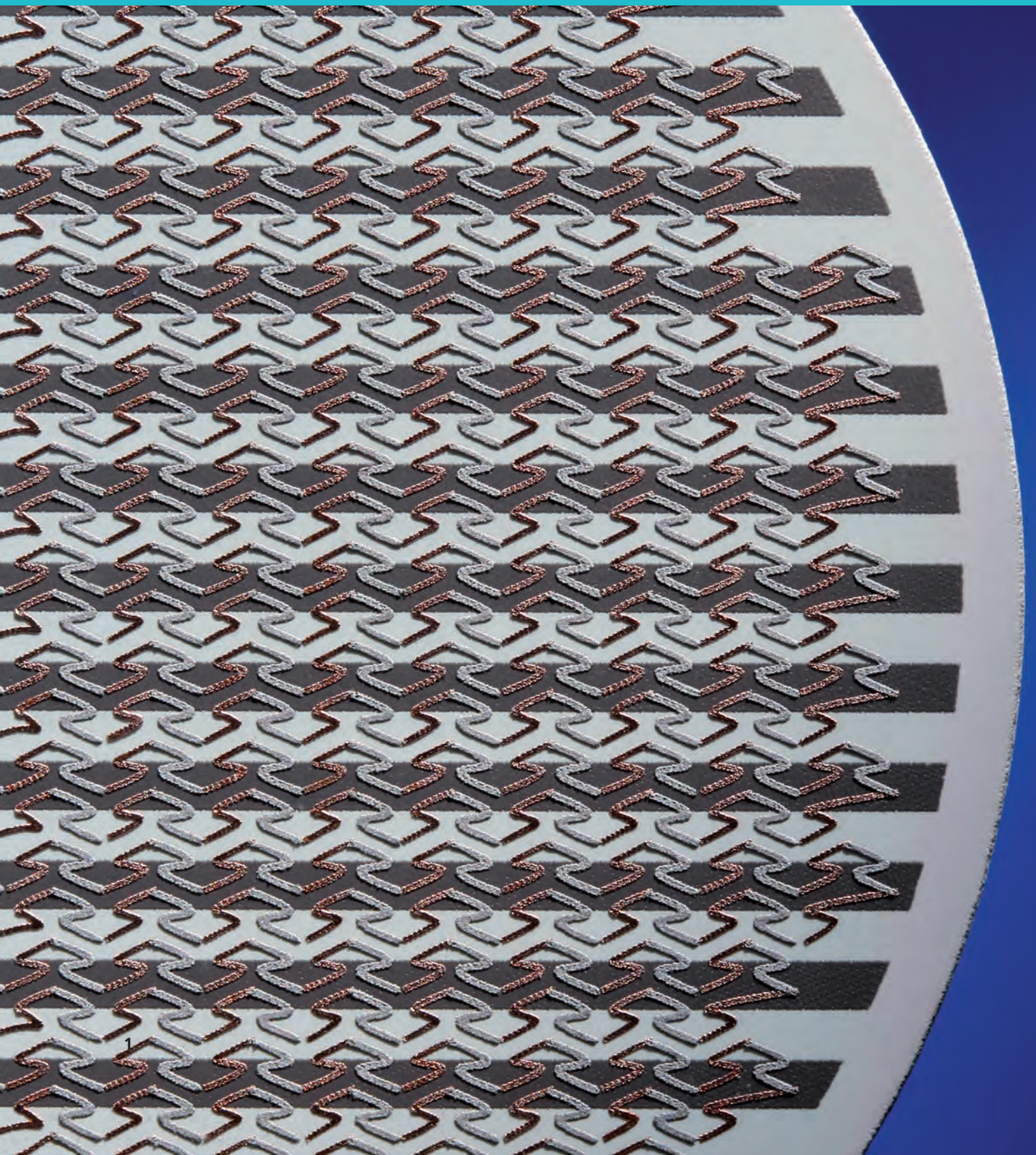

CORE COMPETENCE METALLIC MATERIALS

The development of materials with tailor-made properties or property combinations lies at the center of the core competence "metallic materials" at Fraunhofer IFAM. The use and systematic advancement of casting technology, sintering, and shaping processes as well as additive manufacturing processes open up a multitude of possibilities for the creation and optimization of innovative metallic material systems as well as component geometries with exceptional characteristics, especially by their combination in novel composite materials or their design as highly porous or cellular structures.

In the field of metallic and intermetallic sintered and composite materials for functional and structural applications, Fraunhofer IFAM possesses a deep understanding of structure/property relationships and their application-oriented optimization. Powder technology allows the creation of materials with a predefined property profile. In casting technology, we handle the entire range of casting materials, including aluminum, magnesium, zinc, copper, and stainless steel as well as individual alloys as specified by our customers. Furthermore, special materials, such as metal-matrix composite materials, are developed and optimized for casting technology applications.

Fraunhofer IFAM has a comprehensive knowledge of alloy and process development for the production of lightweight metal parts, particularly from aluminum, for weight reduction in automobile construction. In the research field of metallic composite materials the focus lies on material development for thermal management in electronics, on friction and sliding materials for high tribological demands, and on special materials designed to withstand mechanical and corrosive stress at high temperatures (> 800 °C).

Increasingly of importance are the manufacture and testing of functional materials for energy storage and conversion. Central themes here are novel materials, especially nanostructured

materials for hydrogen generation and storage, heat storage, efficient thermoelectric generators, and supercapacitors as well as magnetocaloric materials.

Magnetic materials play a vital role in energy technology or alternative drive systems. At Fraunhofer IFAM, both hard and soft magnetic materials are being developed, processed with various techniques, and characterized, including the promising field of soft magnetic composites (SMC).

Another development focus lies on cellular metallic materials. Through the broad range of materials and the different specifically adjustable cell or pore structures, various application-oriented properties and reductions in material use can be realized. Thus, it is possible to further develop and implement highly porous materials like fiber metallurgical materials, hollow sphere structures, open-cell metallic foams, 3D screen printed structures, 3D wire structures, or metallic sinter paper, e.g. for sound absorption, heat insulation, energy absorption, mechanical damping, material and energy transport, or catalytic effects.

> www.ifam.fraunhofer.de/metallic-materials

1 *Multilayer screen printing of metallic sensor structures (in cooperation with Ecomatik).*

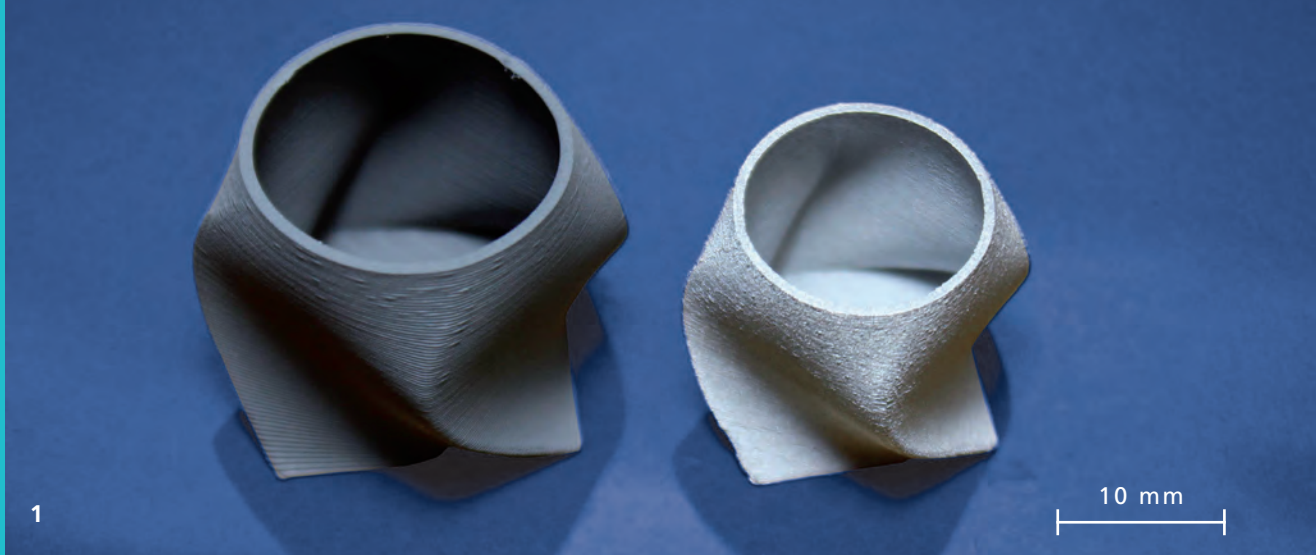

FUSED FILAMENT FABRICATION – VERSATILE AND COST-EFFECTIVE

Additive manufacturing processes for metallic materials are gaining increasing importance in the industrial routines. Future development goals are additional functionalities in conjunction with cost reduction. At Fraunhofer IFAM, new materials and methods are being developed on a powder metallurgical basis in order to overcome existing barriers to the implementation of additive processes.

Fused Filament Fabrication (FFF) is an additive manufacturing process previously limited to plastics, wherein a filament is extruded from a thermoplastic polymer through a heated nozzle and laid in layers on a base according to the layout. In the last few years, first efforts have been made to adapt this process for use with metals. In this variation, the thermoplastic material is homogeneously filled with a metal powder, and the printed component is subsequently debinded in order to remove the plastic to prevent impurities. Finally, the structure is sintered to a dense component that is completely made of metal.

The advantages of FFF for additive metallic components are particularly the low costs and the variety of materials. The acquisition costs for an FFF printer are only 10% of those for a unit for beam-based additive processes. The potential diversity of alloys is very high thanks to the use of industrial standard powders and significantly expands the material spectrum of other additive processes. Particularly attractive is the possibility to mechanically process the component prior to sintering, enabling further functionalities, such as surface smoothing, with the least amount of tool wear.

In the development of metallic FFF, Fraunhofer IFAM with its branches in Dresden and Bremen is assuming a pioneer role. Based on the experiences in the development of MIM feedstocks, 316L stainless steel filaments with a very high filling degree of 60 volume percent could be achieved. The devel-

oped filament can also be used in commercial FFF printers. The material portfolio further includes 17-4PH stainless steel and the ceramic ZrO₂, both individually as well as in composites, while cooperative projects are being planned that involve copper and tool steels.

The mastering of heat treatment for debinding and sintering plays an important role in FFF, as this has a decisive influence on the net shape, achievable densities, and impurity content. In this regard, Fraunhofer IFAM distinguishes itself through its unique powder metallurgical competence.

In the ongoing project AMCC-Line¹ a new manufacturing line is being developed with industrial partners in order to provide customers with a complete production chain, from printing and mechanical processing for green and end processing to heat treatment ovens, in one compact, modular manufacturing unit. The fields of application for FFF and AMCC-Line lie, therefore, in all industrial sectors in Germany, in particular for applications that ask for small to medium batch quantities, special materials with complex shapes, or individualization.

¹ Twisted box (stainless steel 316L, green and sintered).

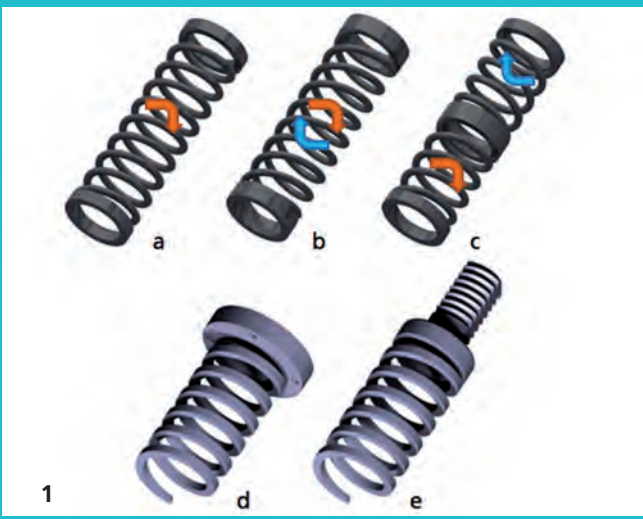

ADDITIVE MANUFACTURING OF TECHNICAL METAL SPRINGS

Technical metal springs are needed in a variety of shapes and sizes for a wide spectrum of technical devices and machines, and they usually interact with many other components as part of an assembly. Their manufacture using laser beam melting (LBM) offers new possibilities.

The need for miniaturization and the reduction of assembly steps demands new spring designs that cannot be realized through winding. However, these can be achieved through additive manufacturing (AM), in particular for springs with complex shapes (Fig. 1).

Balanced torques during compression

When a conventional “single wire spring” (Fig. 1a) is compressed, internal torques try to bend due to their asymmetrical geometry. A “double wire spring” (Fig. 1b), which has two wound wires set at 180° to each other, compensates for this both during compression and decompression.

Rotational freedom during compression

If a conventional spring is compressed, this leads to a light twisting of the spring. If this movement is restricted by a fixed assembly, this can lead to undesirable tensions. A solution is shown in Figure 1c. The spring is divided into two segments, each with a different winding direction, so that the radial movements of both segments cancel each other out.

Additional functions of springs

As technical springs are always part of an assemblage, reducing the amount of effort required in the assembly is of great interest. End mounts on springs enable their connection to other components. The unique freedom of design offered by springs produced using laser beam melting (LBM) opens up the possibility of manufacturing components with connective

elements in one process. Figure 1 shows design concepts for connective elements, such as an integrated flange with mounting holes and an integrated screw with external thread. Also gears, couplers, and threaded holes can be realized.

LBM has many benefits, offering new design concepts for technical springs and enabling the integration of additional functions. Through the continuous expansion of the material range, it is expected that LBM-suitable powder materials for the established spring steels can be developed. For some applications and new spring types, the high degree of design freedom of LBM could be the only viable alternative to wire winding and processing. Thus, LBM can further extend the advantages of processed springs. Fig. 2 shows springs developed at Fraunhofer IFAM and produced using LBM, demonstrating the general processability of complex shapes with additional functional properties.

- 1 Types of cylindrical spiral printed springs: a) single wire spring, b) double wire spring, c) wound from both sides, d) spring with integrated flange, e) spring with integrated external threading.
- 2 Types of cylindrical spiral springs manufactured using LBM.



CORE COMPETENCE POLYMERIC MATERIALS

The importance of polymeric and polymer-modified materials has increased in recent years due to their variable and unique properties as well as their potential to facilitate the reduced use of resources. Novel polymer materials offer technically interesting perspectives and represent an important part of the research efforts of Fraunhofer IFAM in the areas of adhesive bonding, coating technology, and fiber reinforced composites. The focus is on materials that are synthetically created from fossil fuels or renewable raw materials or are formed through the conversion of natural materials.

The competence spectrum in the field of polymer materials ranges from their development, processing, and formulation to material and component characterization and encompasses the entire value added chain from the molecule to the component. The starting point is the molecule design and the synthesis of raw materials for adhesives, coatings, and matrix resins. The focus, however, is on reactive systems, which are processed to thermosetting, elastomeric, or thermoplastic polymers. The institute is intensively developing new tailor-made polymer systems that result in products for applications in lightweight construction, electrical energy storage, and medical technology.

With the goal of equipping components and materials with additional functions, "stimuli-responsive" adhesives, self-healing paint systems, and adaptive composite materials are being developed. Against the background of resource scarcity and increasing environmental pollution by plastics, polymer materials that are based on renewable and/or biologically degradable raw materials play an important role. Therefore, among others, starch-based adhesives for wood, bio-composites made of biopolymers and natural fibers for the packaging and agricultural industries, and chitosan additives for anti-fouling coatings are being developed.

A central part is the material characterization for the determination of material parameters, which are used in combination with

numerical simulations to predict the period of functional use and life time. For the computer-aided evidencing of fiber composite materials and adhesively bonded structures, simplified mathematical models and the finite element method (FEM) are used, from which polymer-specific material models and modelling techniques can be derived. With the support of the affiliated material testing laboratory, material cards can be produced for FEM programs, which enable a material and application-oriented measurement of adhesive bonds and components.

An overarching component of this competence is quality assurance. The continuous monitoring of the reaction processes of polymer materials as well as of the finished component through customized analyses is an essential tool for the assurance of a reliably high product quality. This is supported by the certified qualification of personnel that reaches across industrial sectors and products. This professional training enables technology transfer, introducing scientific knowledge and methods into industrial applications.

> www.ifam.fraunhofer.de/polymeric-materials

1 *The sea urchin moves with the aid of adhesive secretions and enzymes that dissolve its bond with the substrate.*



VALORIZATION OF BIO-BASED RAW MATERIALS

The development of raw materials based on biomass is becoming increasingly attractive and important due to the various legislative initiatives and changing consumer and manufacturer attitudes. It can be assumed that the volume of “green material” will grow in the market. The Valor Plus project has developed new findings and approaches in the field of biotechnology and bioproducts and the industrial application of bio-based raw materials.

These three areas are tightly linked, as only optimized biotechnology can offer competitive bio-based raw materials in large quantities. In turn, biorefineries can only advance from the first to second or third generation if potential end applications of the raw materials have come so far that the manufacturer of the bio-based raw materials can recognize potential markets. Simple biorefineries, which use consistent qualities of individual biomasses, are the technological standard, but in order to achieve significant advances, the use of very different source materials is unavoidable for the manufacture of a high variety of products, including energy and chemical products.

Bio-based binding agent for primer formulation

A result of the project is the possibility of using lignin as a raw material for the manufacture of binding agents for the adhesives and coatings industries. During the development of alternatives to petrochemical substances, lignin often comes into focus; however, the wood-based material has so far not stood out due to its challenging properties. For example, the precise chemical composition of the lignin mass depends on whether it has been sourced from paper manufacture and has been mixed with other substances or whether it originates from the production of biofuels. Most previous approaches were based on producing monomeric starting materials from lignin that consistently have the same properties. Due to the different compositions of the original material, this is quite

complex; however, through standardization and modification, a raw material can be produced that always remains within certain limitations. This can then be used as a component of a binding agent for primer formulations, resulting in a primer that possesses key features, such as corrosion protection, adhesion, and applicability, that are comparable with petrochemically based primers.

1 *Lignin is a real alternative to fossil fuel based raw materials in the manufacture of primers or adhesives.*

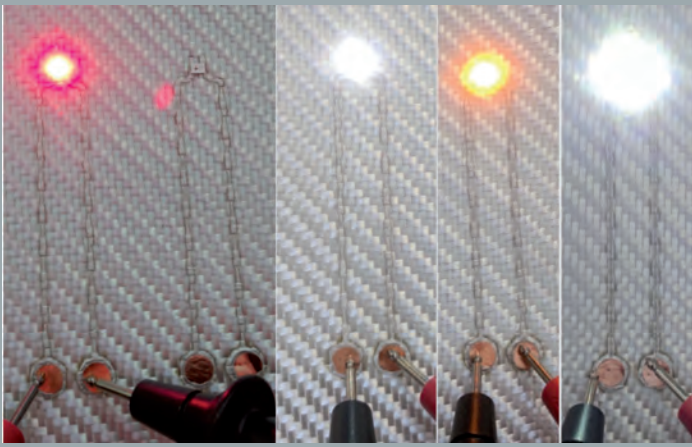

1

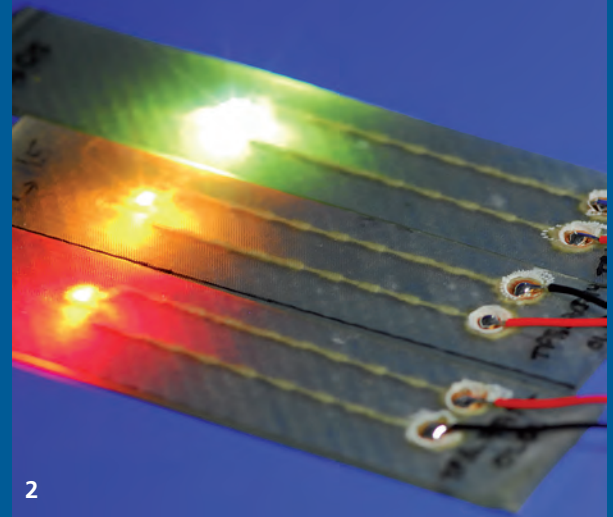

2

FUNCTIONAL INTEGRATION IN FRP WITH DIGITAL PRINTING

Glass fiber reinforced plastics (GFRP) and carbon fiber reinforced plastics (CFRP) are increasingly being used in lightweight construction due to their light weight and rigidity. However, they are often still produced in manual process chains entailing frequent variations in quality. Moreover, non-destructive testing methods suitable for FRPs are missing. Therefore, the advantages of these lightweight materials can currently not be completely utilized as any damages to the fiber structures, for example due to manufacturing or a hard impact during application, are rendered undetectable.

Structural components of FRP are therefore constructed with a large safety margin in order to ensure sufficient reliability, which leads to increased costs. Predictive maintenance during operation (structural health monitoring – SHM) can reduce the need for safety measures and thus save costs. In order to achieve this, sensors and the related electronics have to be integrated into the fiber composite structures. Ideally, damage would be detected not only on the surface but also in the component's interior, whereas the stability of the FRP itself must not be affected. The integration of very thin foil-based sensors is problematic, since these may in extreme cases lead to a delamination of an FRP component and thus to a failure of the FRP structure under higher loads.

In the sub-project B "Smart Wing" of the Fraunhofer lighthouse project "Digital Manufacture in Mass Production – Innovation for Series Production with Digital Printing and Laser Processes – Go Beyond 4.0", sensors and electronics for the monitoring of load conditions are integrated into and onto FRP components using digital printing processes. In this way, components can be exposed to high loads, while reliably - thanks to the permanent monitoring, any damages can be detected at an early stage. In addition, during the manufacture, sensors and actuators or even heaters and antennae can be integrated at relevant positions into an FRP component. Digital printing

and laser processes allow us to print functional materials, such as sensor structures, locally onto an FRP surface, thus functionalizing a component. The integration of electrical, sensory, or capacitive functions within the fiber composite is also possible: Digital printing processes allow the direct application of functional structures with a high resolution to the fiber glass webs that are used as fabric layers in the manufacturing process of the fiber composite material. In the case of carbon fibers, these must first be electrically insulated. For this step, printing processes are suitable as well, applying insulation and barrier materials directly to the fibers. Following the printing process, the applied functional materials must generally undergo a thermal treatment, which occurs locally via laser or energy-rich UV radiation. The printed semi-finished textile materials can be directly implemented using conventional technologies for the manufacture of function-integrated FRPs.

- 1 *Tracks consisting of silver-polymer composite on glass fiber printed using a digital dispensing process; subsequent integration of LEDs.*
- 2 *Function-integrated LEDs in glass fiber plastic material.*

SURFACE TECHNOLOGY

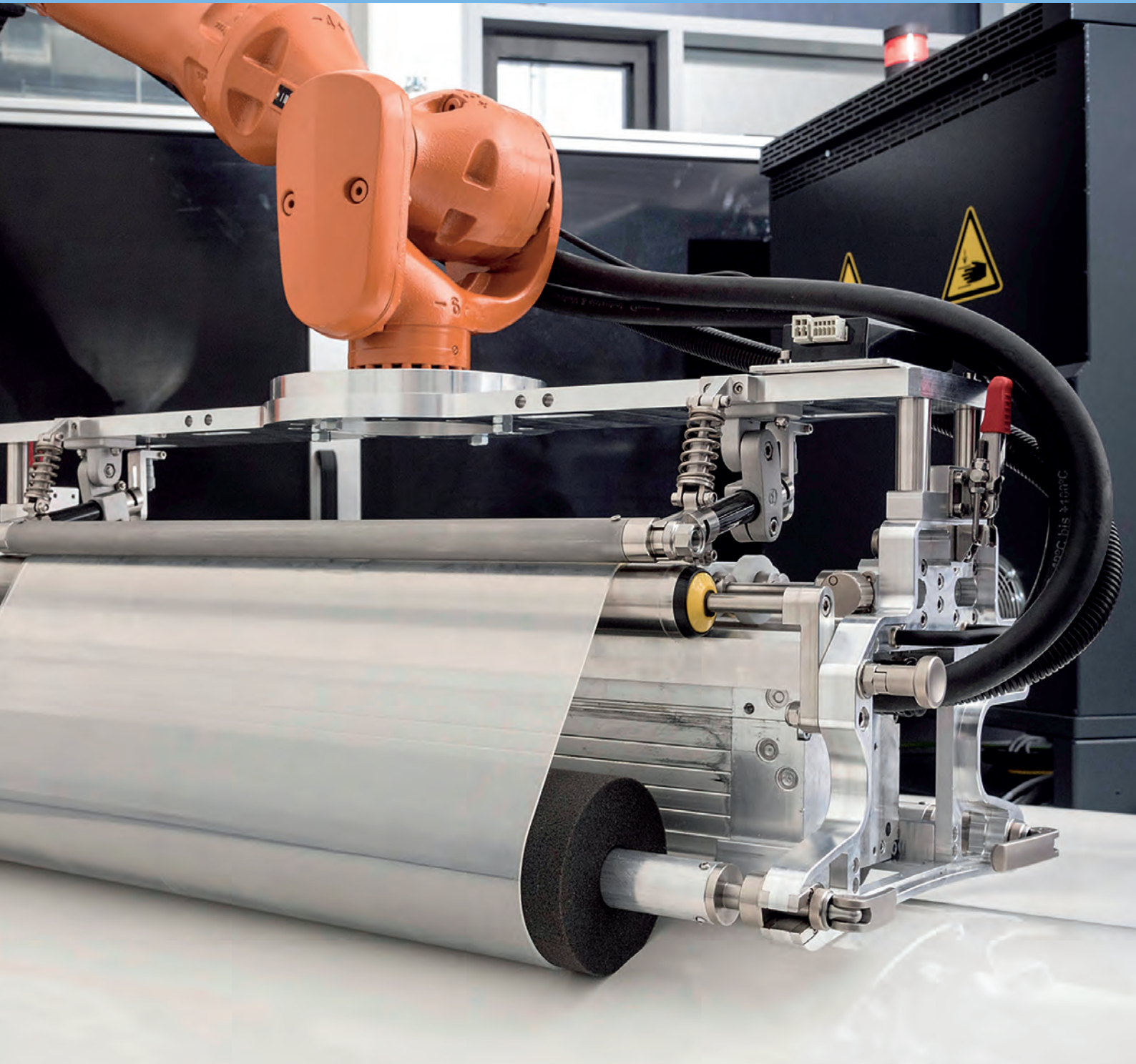

CORE COMPETENCE SURFACE TECHNOLOGY

New materials are drivers of innovation and are found in key technologies in daily life. The wide variety of industrial uses of many materials is expanded, or indeed made possible, through the customized modifications of their surfaces. Fraunhofer IFAM possesses many years' worth of wide-ranging expertise in surface technology, as evidenced by its many innovations in conjunction with partners from widely differing sectors.

Fraunhofer IFAM orients itself towards industrial development and manufacturing processes in surface technology, ranging from material science research to the development of new coating materials and treatment processes. Our partners can make use of our competences in the characterization and evaluation of surfaces, their functionalization and modification, as well as in regard to the related application processes with the right quality assurance.

Key points of our work include the development of, e.g., wet and dry chemical cleaning and surface pre-treatment techniques, coating materials and processes, printing processes, and thin film and thick film technologies as well as aspects of modern quality assurance in production monitoring. The characterization and evaluation of surfaces via chemical, electrochemical, and structural analyses offer valuable information about their composition and properties and are complemented by various computer-aided simulations and a wide range of testing facilities.

The experts at Fraunhofer IFAM have comprehensive knowledge of customized surface modification and functionalization of surfaces. This includes cleaning and activation as well as suitable pre-treatment prior to coating and adhesive bonding. The demands placed on technical surfaces are multiple and depend on each respective application. For example, currently in

the works is the development of low-drag, ice and dirt repellent, antibacterial, biocompatible, and anti-fouling properties. Also, specific tribological, optical, or electrical demands as well as the equipping of surfaces with sensors can be achieved. In addition, various application processes are offered, ranging from the laboratory scale and pilot projects to upscaling and robot-supported automation for large series production.

Quality assurance plays a central role in surface technology. Therefore, Fraunhofer IFAM develops production-integrated quality assurance concepts and test methods that allow a stable process control, while also taking into account the new demands being placed on quality assurance by the trend towards digitalization in the production area. In addition, the institute has accredited test facilities that can also be used for damage analysis. Subject-specific training and a regular transfer of technology to industrial practice complete the core competence "surface technology" division.

> www.ifam.fraunhofer.de/surfaces

1 *Riblet applicator.*

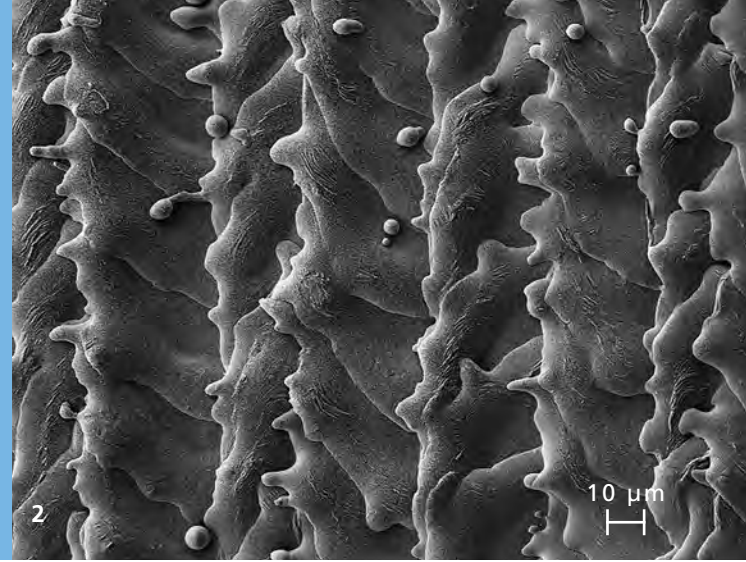
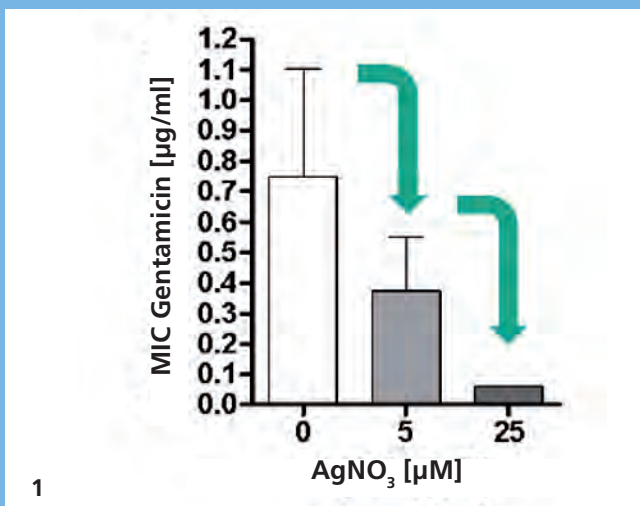

SURFACES FOR MEDICAL TECHNOLOGY

Surface technology plays a very important role in implant technology as the interactions between a titanium implant and the surrounding tissue as well as with other materials are primarily determined by roughness and surface energy properties.

The goal of the “Synergy-Boost” MAVO project is the suppression of implant-associated infections by creating a porous implant surface that absorbs an antibiotic. To further support topical antibiosis, silver ions serve to multiply the action of the antibiotic through a synergistic effect (Fig. 1). The aim is to determine particularly favorable combinations of Ag⁺ and various antibiotics, depending on their concentration. The subsequent insights are to be used to develop an antibacterial coating for trauma implants. A particular feature of the patented coating is that it allows a patient-specific selection of the antibiotic since the antimicrobial agent is not introduced into the implant surface by the impregnation process until immediately prior to implantation. The porous surface is produced through either the established micro-arc oxidation process or an innovative laser process. The project ends with two animal-based studies (“orthopedics” and “dental”) to demonstrate the usability of the coating concept.

The osteosynthetic treatment of bone fractures uses trauma implants and intramedullary nails, which are generally removed once the fracture has healed. The removal of the implant can be facilitated by hydrophobic, low-energy surfaces, thus reducing soft-tissue damage, shortening the healing time, and reducing the risks of complication. As part of the “Trauma” project, a suitable cell adhesion-reducing and non-cytotoxic coating based on Light^{PLAS}® technology was developed. The starting point for the layer comprises non-re-

active and medically approved materials that are crosslinked using vacuum-UV radiation to form a coating.

Shape memory alloys made of nitinol (NiTi) are an important material in the field of medical technology (stents, endoscopes). The bonding of nitinol with other materials can be effected in a particularly space-saving manner using adhesive technology, which also enables the use of NiTi-medical steel hybrids. In the moist and humid environmental conditions found in medicine, bonding is a particular challenge. With the help of laser processes, the project “Dr. Bond” aims to create a surface that ensures the long-term stable adhesion of biocompatible materials (Fig. 2).

- 1 *By adding a non-antimicrobial effective amount of silver, the minimum inhibitor concentration (MIC) can be reduced by a factor of ten.*
- 2 *Laser-structured nitinol (NiTi) surface for improved adhesion in wet environments.*



DIGITALIZATION IN THE QUALITY ASSURANCE OF SURFACES

Digitalization is finding its way into all areas of industry and everyday life. Assuming quality assurance to be a cross-process function along the entire production chain, digitalization now offers previously unrealized potentials in that area. Therefore, Fraunhofer IFAM is analyzing new approaches in the field of adhesives and surface technology that use techniques of the Industry 4.0. Specifically, the objective is the symbiosis and merging of new technologies with existing know-how and established procedures in the quality assurance of surfaces.

One of the main challenges of digitalization is evaluating which of the current technology advances offer promising added value and how to integrate these into an industrial environment. Advances in areas such as machine learning in conjunction with the generation of measurement data now allow more precise and earlier conclusions regarding causes for rejects or downtimes in production. Combined with industrial image processing and the greatly improved accessibility of advanced algorithms, these advances can be effectively translated into the quality assurance of surfaces. For example, surface defects can be detected automatically based on training examples given by experts. Repetitive visual surface monitoring tasks can be done automatically using machine learning in combination with robotics.

Another important area of research concerns the introduction of an expert-on-demand system known as IRIES. By applying new technologies such as smart glasses or smartphones, a technician can request direct support from an expert while on location, for example in a workshop, meaning inspections can be done anywhere and as needed. The expertise of the experts at Fraunhofer IFAM can thus be used more efficiently in the future and thereby is more conveniently available to the customer.

To enable the long-term use of the generated data, information must be stored centrally and converted into a suitable structure. Therefore, researchers at Fraunhofer IFAM are investigating the use of standardized data formats. In this way, data of various material and surface inspections can be managed efficiently. Graphical processing of these data can also help to better understand measurement results and ensures that all process participants have easy and suitable access to that data.

Overall, digitalization facilitates a better understanding of processes and the ability to identify causes of problems faster with the objective of assisting people in their work: Starting from improved interfaces to measuring instruments and user-friendly visualization of results to a complete autonomous data acquisition using robots and the automatic data analysis in the cloud.

1+2 *Expert-on-demand-system IRIES in action.*

SURFACE TECHNOLOGY

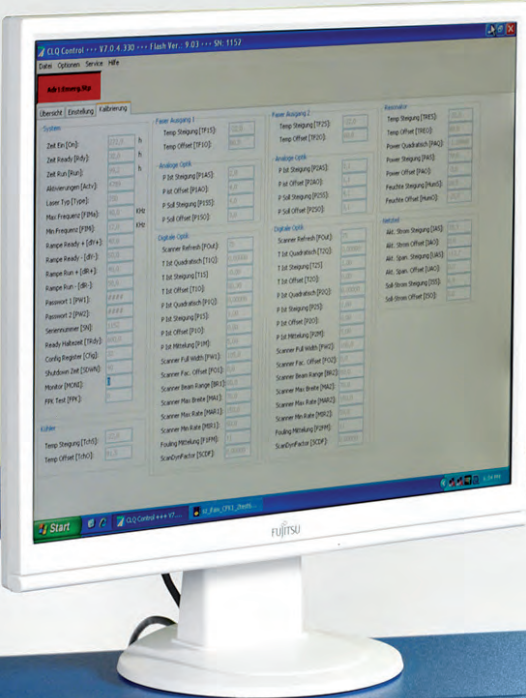

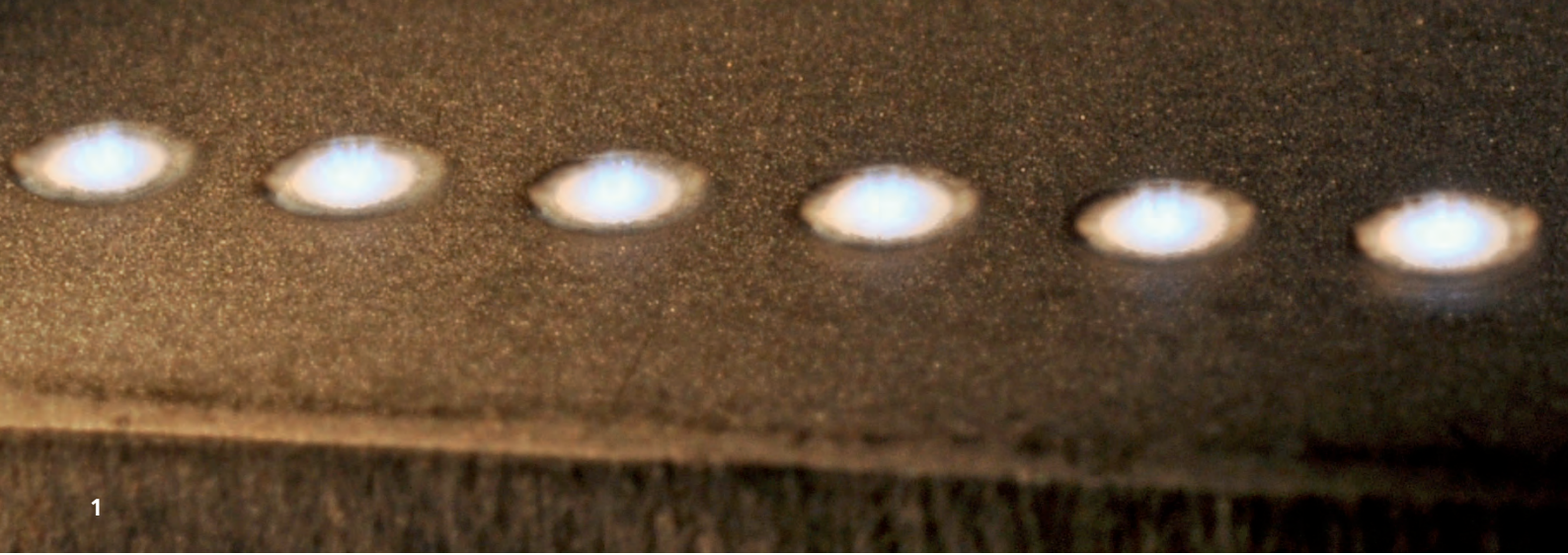

1

FUEL EFFICIENCY THROUGH THE LASER PRE-TREATMENT OF TITANIUM

Hybrid structures made of titanium and carbon fiber reinforced plastics (CFRP) are becoming increasingly important in the aerospace industry. To reduce fuel consumption, next-generation aircraft are to be fitted with, for example, perforated titanium sheets in the area of the leading edge of the wing. This special perforation prevents turbulent flows and thus reduces air friction and fuel consumption. Ideally, the titanium sheets and the CFRP wing are adhesively bonded. To this end, Fraunhofer IFAM is developing processes for the laser pre-treatment of titanium in order to ensure the necessary structural strength of this essential structure.

“CleanSky” is the largest European research program with the aim of significantly reducing CO₂ and noise emissions during aircraft operation by offering innovative technologies. Together with many other well-known companies in the aerospace industry under the leadership of Airbus, Fraunhofer IFAM is working in close cooperation on the validation and further research of one of the future key technologies for reducing emissions, the so-called HLFC (Hybrid Laminar Flow Control) concept.

This concept targets a significant reduction in the frictional resistance through different aerodynamic measures in the area of the wings. Within this framework, Fraunhofer IFAM is involved in the conception, production planning, and manufacture of a demonstrator component on a 1:1 scale for large passenger aircraft. An essential key component in the manufacture of the prototype, as well as in future production, is ensuring a long-term durable adhesive bond between titanium and the CFRP leading edge of the wing. The main focus of the work at Fraunhofer IFAM in achieving this is the development of a suitable laser pre-treatment process of titanium. Scientists in the departments of Material Science and Mechanical Engineering as well as Plasma Technology and Surfaces are focusing on the modification of titanium surfaces. The influence

of parameters during laser treatment (such as wavelength, fluence, and beam parameters) on the synthesis of different titanium oxide surfaces is specifically being investigated. The work is accompanied by the structural characterization and testing of the adhesive bonds thus produced in order to clarify the role of the titanium oxide surface in long-term stable bonding.

The initial findings suggest that the high safety requirements for a structural titanium-CFRP bond in the aviation industry can be guaranteed by laser pre-treatment. These results are, of course, transferable to other applications and significantly extend our expertise in developing optimal pre-treatment processes for our customers. In conjunction with our new inline pre-treatment center, the process time, space, and budgetary conditions can be optimized for the integration of pre-treatment into industrial production.

- 1 *Nd:YAG laser for the pre-treatment with an infrared laser beam.*
- 2 *Interaction of a laser pulse with a titanium surface.*

ADHESIVE BONDING

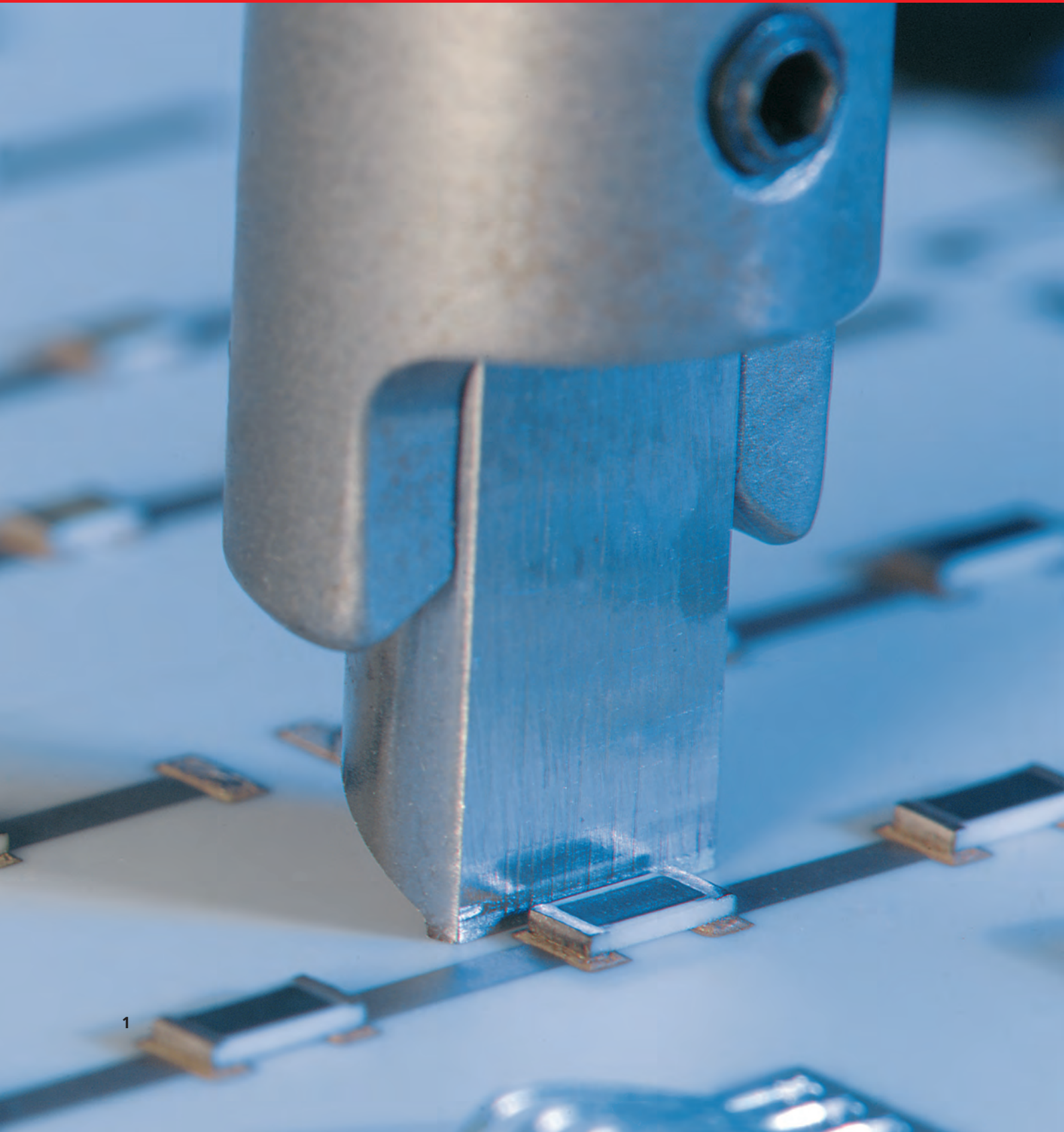

CORE COMPETENCE ADHESIVE BONDING

Fraunhofer IFAM is the leading international independent research institute in the field of adhesive bonding. Highly qualified multidisciplinary teams have been working on the advancement of this multi-faceted joining technology for almost 50 years. The many years of experience, diversification of the employees, and comprehensive equipment enable a fast and high-quality fulfillment of services as well as research and development commissions.

The core competence "adhesive bonding" at Fraunhofer IFAM includes the selection of adhesives, the characterization of mechanical properties, the processing properties of adhesives, the design and validation of adhesively bonded structures, the development and application of dosing and application processes, quality assurance, the customer-specific design of industrial processes, the analysis of damage, the mitigation of production disruptions as well as the inter-organizational, cross-hierarchical qualification of company personnel.

Challenges such as the promotion of adhesion, high-temperature applications, and aging protection are just as much a part of the portfolio as fast curing and hybrid joining. For the characterization of adhesives and adhesive bonds, a broad spectrum of thermoanalytical, spectroscopic, rheological, physical, and mechanical test methods is used. These are of crucial importance in estimating the aging behavior and lifetime of the end product.

With demanding joints or difficult surfaces, a surface pre-treatment may be necessary prior to bonding. This ensures the long-term adhesion of the adhesives. The integration of adhesive bonding into industrial manufacture requires technology that is tailored to the specific application. Process automation is thus of particular importance. The same applies to the design of adhesive bonds and the determination of adhesively bonded structures. These are based on the experimental variables of the adhesives, materials, joints, and components, which

are determined in our DIN EN ISO 17065 accredited testing laboratory.

Customers from the industry appreciate our advice on adhesive issues. Such consultation often begins with a visit to the site and the creation of a specification sheet. The selection of suitable adhesives is tailored to the specific requirements of the customer. As an option, this can include this specific surface treatment of the joining partners, the automation of the adhesive application, and even the introduction of a quality-assured manufacturing process in the company.

A long-standing, comprehensive, and globally available portfolio of technical adhesive training with internationally recognized certification is another essential element of the quality assurance concept for adhesive bonding.

A review of the standard implementation of industrial adhesive bonding technology, based on DIN 2304 "Adhesive Bonding Technology – Quality requirements for adhesive processes" is one of the services offered. The Fraunhofer IFAM also provides DIN 6701 accredited auditors for adhesive bonding in rail vehicle construction.

> www.ifam.fraunhofer.de/adhesivebonding

1 *Testing the bond strength of an SMD structural component that is contacted with an electrically conductive adhesive.*

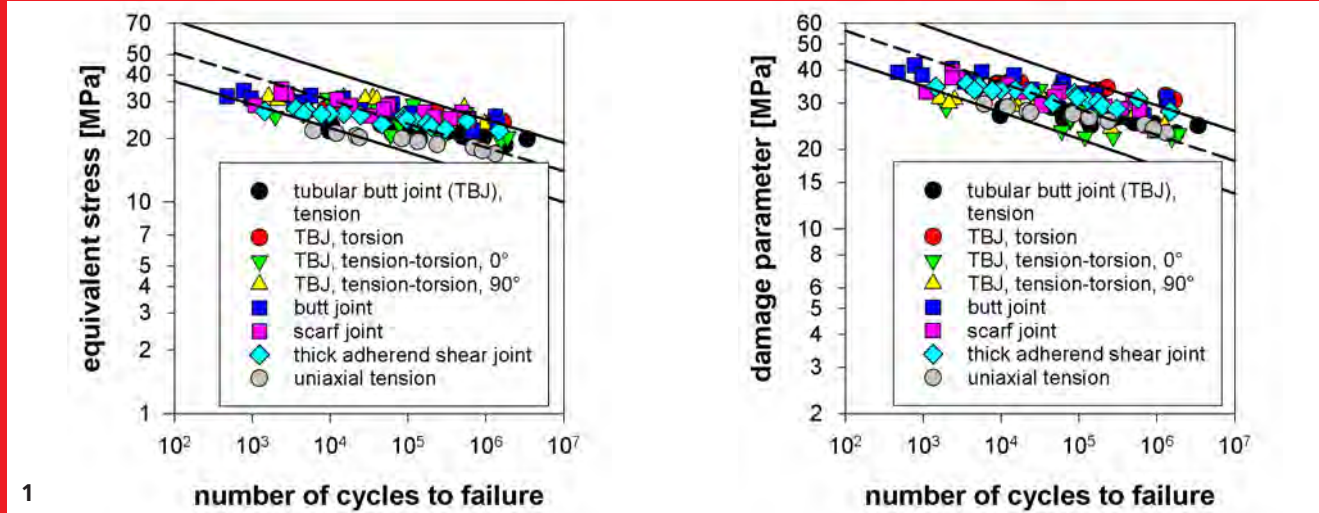

FATIGUE BEHAVIOR OF ADHESIVELY BONDED STEEL JOINTS UNDER NON-REVERSED LOADS

The mechanical behavior of structural adhesive layers was investigated using multiaxial fatigue loading. Here, the load-time functions were applied both individually and in combination, resulting in multiaxial stresses that were either proportional or non-proportional to the applied load. This form of stress represents a general case that is relevant to the application. The investigation was driven by the need for data and methods for the design of adhesively bonded steel joints in the automotive industry.

To estimate the lifetime of adhesively bonded components, stress-based failure criteria were examined and further developed. Both invariants of the stress tensor as well as critical plane criteria were considered. From both approaches it is known in the field of metallic materials that multiaxial stresses can be mapped onto a common reference S-N curve. A common S-N curve means that a valid failure criterion should take the same value at the point of failure for arbitrary stress states. Invariants are easier to use but are limited in that a non-proportional load is generally not well described. Critical plane approaches can be used to describe both proportional and non-proportional stresses [1-3].

Parameter sets were identified for both groups of failure criteria by testing samples with a homogeneous stress state in the adhesive layer. Using suitable geometric design, different ratios of shear stress to normal stress were achieved. With tubular butt joints, shear and normal stresses in the adhesive layer were superimposed either proportionally or non-proportionally. The tests were performed in force-controlled mode in servo-hydraulic tension and tension-torsion testing

machines. The fracture patterns of the tested samples showed complete cohesive failure within the adhesive layer. The results could thus be fully attributed to the cohesive properties of the adhesive layer.

Figure 1 shows fatigue test results with different loading axes and a phase shift, which are mapped onto a common S-N curve based on an invariant criterion and a critical plane criterion using the normal stress. The adhesive is a one-component thermosetting epoxy resin used in structural joints in automobile manufacture. The shear-normal stress ratio in combined experiments was about 1:1, the phase shift was 0° and 90°, and the load ratio was $R = 0.1$. The figures suggest that both criteria are comparable regarding their predictive capability. However, a more in-depth analysis showed that the lifetime under phase-shifted loading was better described using the critical plane approach.

The predictive capability of the models was verified in further experiments. For this purpose, using the previously identified models, lifetime predictions under fatigue load were made for

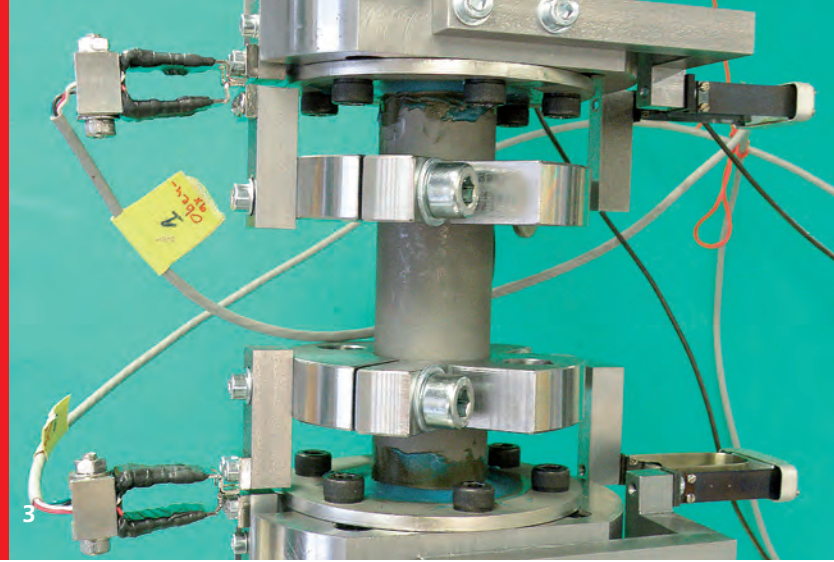

component-like samples with inhomogeneous stress states in the adhesive layer. Flange rod samples (Fig. 2) were used as component-like test samples, whereby both in-phase and phase-shifted loading could be realized.

Oscillation tests were carried out on the previously calculated flange rod samples. The generated database fulfills the requirement of independence for the verification of the prognosis ability, that is, it was not used for parameter identification. The ratios of load and torque and the decrease in the transmittable torque at superimposed axial load were well described by the model. The tendency towards an early failure in the experiment was a consequence of imperfections in the adhesive layer as a result of fabrication.

The results show that the lifetime of the considered adhesive under multiaxial loading can be predicted based on stress-based failure criteria. The general case of non-proportional loading is better described by the critical plane approach than by invariants. A further validation of the examined calculation approaches regarding their use with alternating loads and transferability to other adhesives requires future investigations.

Acknowledgement

The IGF project 18107 N of the Forschungsvereinigung Stahlanwendung e. V. (FOSTA), Sohnstraße 65, 40237 Düsseldorf, was funded by the Federal Ministry of Economic Affairs and Energy via the AiF as part of the program for the promotion of industrial joint research (IGF) based on a resolution of the German Bundestag.

- [1] D. F. Socie and G. B. Marquis, *Multiaxial Fatigue*, Warrendale: Society of Automotive Engineers, 2000.
- [2] E. Haibach, *Betriebsfestigkeit: Verfahren und Daten zur Bauteilberechnung*, Berlin: Springer, 2006.
- [3] D. Radaj and M. Vormwald, *Ermüdungsfestigkeit: Grundlagen für Ingenieure*, Berlin: Springer, 2007

- 1 Representation of fatigue test results on a common S-N curve $\sigma = \sigma_0 N^{1/k}$ using an invariant criterion (left) and a critical plane criterion (right).
- 2 Flange rod samples.
- 3 Fatigue tests on a flange rod sample.



STUDYING ADHESIVE BONDING TECHNOLOGY: IN-SERVICE TRAINING

The Training Center for Adhesive Bonding Technology of Fraunhofer IFAM, the Steinbeis University of Applied Sciences Berlin (SHB), and the Steinbeis Center for Management and Technology (SCMT) have cooperatively developed in-service training in the form of a Master of Engineering (M. Eng.) degree and the internationally recognized DVS®/EWF – European Adhesive Engineer – EAE degree.

The concept

The aim of this new in-service training is to educate employees quickly and comprehensively from both technical and economical perspectives, taking into account social and intercultural aspects.

Structure and content of the course

A key part of the in-service training is the two-year project competence program PKS, where, in addition to the technical transfer of knowledge, a concrete project within a company always takes center stage. The study content is presented in short attendance periods (one to two-week seminar blocks). The central component of these seminar blocks is the DVS®/EWF-EAE course with eight one-week modules, during which the employee is still available to perform their duties at their company. A special feature are the project competences associated with PKS. To this end, a project is derived from the trainee's practice and is completed during the project phases. It ends with the scientific elaboration in the form of a master's thesis.

The structure of the study is subdivided into project and attendance phases (16 seminar weeks).

The examination and instruction language of the Master of Engineering including DVS®/EWF-EAE is English and only the EAE course is conducted in either German or English. During the regular 24-month study period, the students visit the study

locations Berlin, Stuttgart, and Bremen, supplemented by stays abroad in Europe and Asia.

Curriculum

The content of the study can be divided into two parts, namely economics (40%) and engineering (60%).

- Focus on economics
- Project management and organization
- Economics – business and law
- Strategies in business administration marketing and business management
- Focus on engineering
- Production and process technology – an introduction
- DVS®/EWF course European Adhesive Engineer – EAE

Outlook

High-potential employees from the company can receive in-service academic training in adhesive bonding, with two degrees available: Master of Engineering – M. Eng. as well as DVS®/EWF-European Adhesive Engineer. They can immediately implement the competences they have gained in their companies.

1 Classroom scenario.

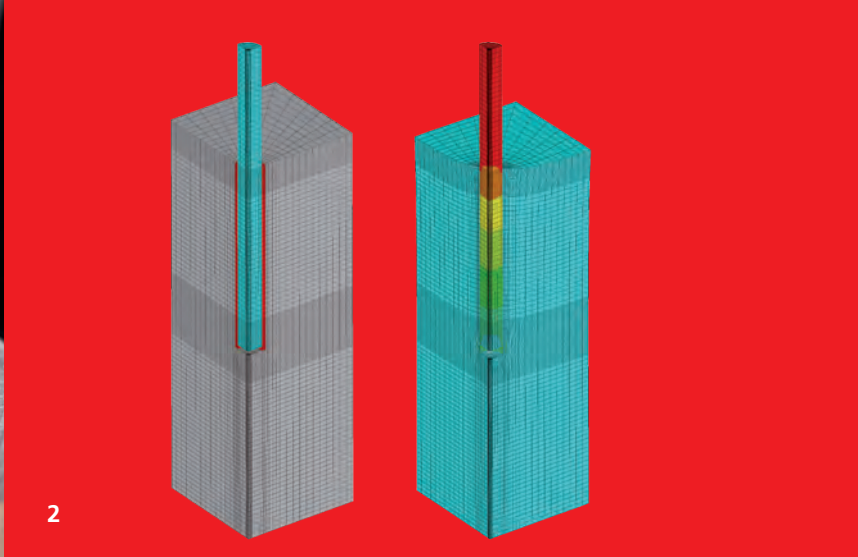
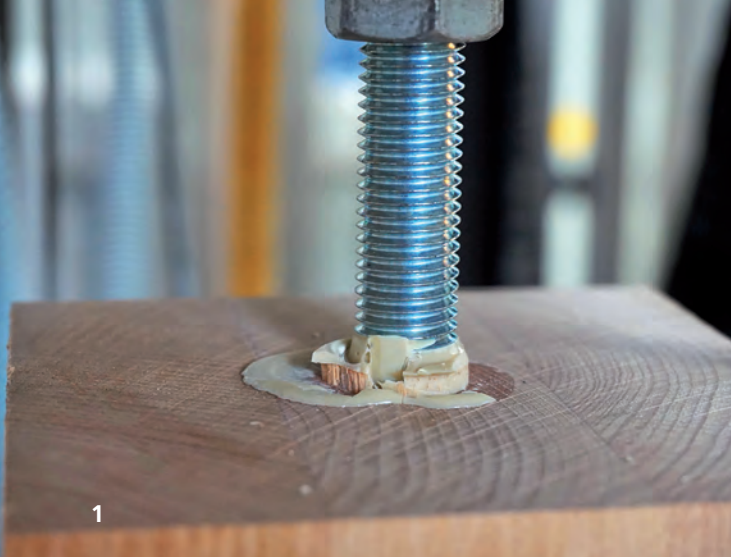

RODS GLUED INTO HARDWOOD

Wood as a building material is currently experiencing a significant upturn. Its high availability, its economic benefits, the architectural possibilities opened up by the use of this natural raw material, and the favourable indoor climate it creates are all leading to an increased use of this material in the construction industry.

With regard to structural materials, bonding technology combined with modern, computer-aided processes enables the development of efficient engineered wood products such as glued laminated timber (GLT) and laminated veneer lumber (LVL). Glued-in rods represent a special form of adhesive joints in timber construction and allow the production of very efficient and aesthetically high-quality joints. Compared to mechanical connections, they have both a higher load capacity and a higher rigidity. These properties have been extensively studied and in part been cast into standards for softwood, but not, so far, for hardwood.

Extensive experimental and numerical research on this topic has now been carried out at Fraunhofer IFAM. Hardwood-based engineered wood products (beech glulam, oak GLT, and beech LVL) were examined by combining four types of rods with nine adhesives (Fig. 1). In the course of the investigations, the optimal adhesives for these applications were determined and characterized, demonstrating that the load-bearing capacity for hardwoods, with the right adhesive, is at least twice as high as for soft woods, both under quasi-static loads and under conditions of fatigue.

It could also be shown that the stress state in glued rods is complex and cannot be reduced to pure shear stress. Significant transverse tensions interfere with shear stress and raise the prediction and computation of the strengths to a more complex level. Using a computer-aided calculation process developed at Fraunhofer IFAM, the quasi-static load capacity of rods glued into hardwoods could be reliably determined

(Fig. 2). This process has been successfully extended to the estimation of residual strength under fatigue loads. The fatigue behavior of glued rods was modeled through damage accumulation. It was thus possible to calculate fatigue loads and to determine the influence of strength degradation on the overall strength by the residual strength after each cycle.

The investigations resulted in the first basic findings on glued rods in hardwoods, helping to increase the efficiency of hardwood-based structures in the future and enabling their application in construction. The results, especially with regard to their insights into the effect of cyclical loads, aid in the design of less conservative and thus more efficient measurements.

- 1 Tensile test on a threaded rod glued into beech LVL (\varnothing 16 mm).
- 2 Numerical model for the computer-aided determination of the load capacities of rods glued into hardwood.

SHAPING AND FUNCTIONALIZATION



CORE COMPETENCE SHAPING AND FUNCTIONALIZATION

Well beyond a mere mastery of the production process from material to component, the core competence "shaping and functionalization" includes the development of innovative manufacturing processes that allow components to be furnished with extra features – without additional effort.

A major focus of the work in this core competence is the comprehensive know-how in various powder-technological shaping and manufacturing processes, and particularly in the two most important process steps: shaping and sintering. Unique among manufacturing processes, the powder-based production of components allows the simultaneous adjustment of material properties and component geometry. Our offer encompasses component development and the production of pilot series as well as the transfer of know-how and the qualification of production personnel.

The use of additive manufacturing technologies, in which components can be created from powdered materials directly from CAD files and without the use of tools in almost arbitrary and very complex shapes, enables the manufacture of prototypes for fast product development as well as highly individualized products for the end user.

Components can be functionalized after production either by applying functional coatings or through functional printing. Various powder-based printing technologies are therefore also an important element of the core competence. With our special in-house designed automated production line, this process is being implemented on an industrial scale.

With regard to casting technology, industrial customers are supported throughout the entire implementation of their ideas from the prototype to the finished product. Key

elements of the core competence are our many years of experience, along with the process chains and plant technology available at Fraunhofer IFAM for die casting, low-pressure casting, lost foam casting, and investment casting. Just as with functional printing, the main focus in casting technology is on the development of function-integrated castings. Already during production, fibers – such as carbon, ceramic, or glass fibers – are integrated directly into the cast component for the systematic tailoring of such mechanical properties as strength or rigidity. Embedded RFID transponders permit a distinct identification and tracing of castings and offer protection against plagiarism. The embedding of sensors and actuators allows castings to have extended sensory or actuator functions.

The core competence "shaping and functionalization" is complemented by a variety of supporting technologies. This includes the simulation of shaping processes, topology optimization, and a full range of analytics with a special emphasis on powder characterization and rheology.

> www.ifam.fraunhofer.de/shaping-functionalization

1 *Design study on laser beam melting.*

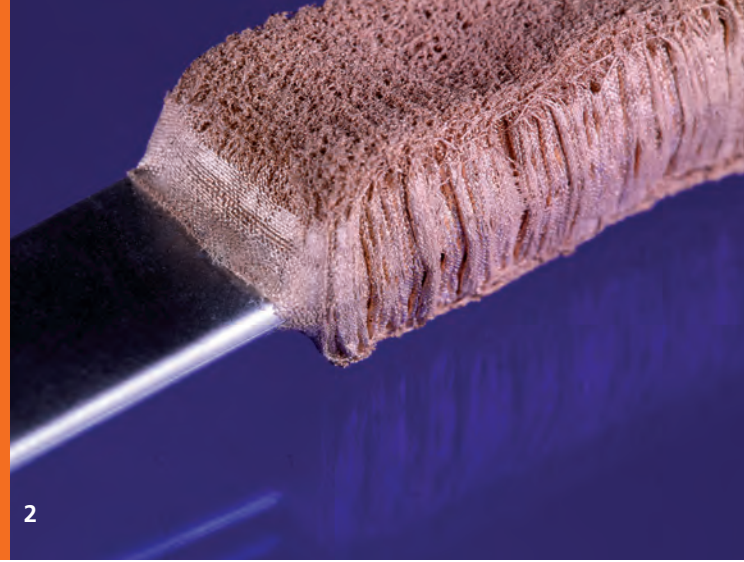
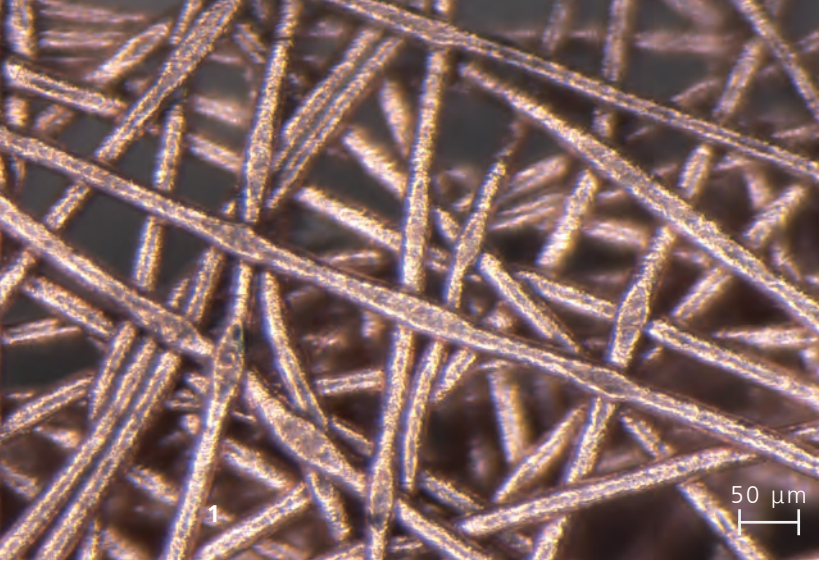

TEXTILE HOLLOW FIBER STRUCTURES FOR THERMAL APPLICATIONS

Metal heat exchangers play an essential role in many technical processes, e.g. in refrigerators, heat pumps, and steam generators. The optimal design of heat exchangers determines the performance parameters of the respective system components; these in turn affect the efficiency levels of the overall processes as well as the necessary sizes of the elements and the system as a whole.

Porous metal structures offer various advantages for the optimal design of heat exchanger components: Their complex web structure has good thermal conductivity and can be used for intensive heat and material exchange. The high specific surface area offers the possibility to deposit thin layers of active materials, such as zeolites or metal organic frameworks (MOFs).

Various starting materials (e.g. melts, powders, fibers) and processes (e.g. casting, deposition, or powder metallurgical processes) can be used for the production of porous metal structures. Within the framework of the Fraunhofer Stiftung Project “Highly Efficient Adsorption Compound Systems for Energy Technology” (HARVEST), Fraunhofer IFAM is developing very fine metallic copper heat exchange structures. Metal coated polyamide textiles, e.g. fleeces or fabrics, from Statex Produktions & Vertriebs GmbH in Bremen are the starting point. The underlying polymer can be removed using special heat treatment, leaving behind a purely metallic textile structure consisting of hollow fibers, which can be easily connected through sintering to solid components such as round or flat pipes, lamellas, or foils. The very thin walls of the metal coating (approx. 1-3 μm) as well as the flexibility of the fibers facilitate a highly conductive joining of hollow fibers, both to each other and to larger components.

With this method, the wide range of design possibilities for textile processing can be exploited to produce the best highly porous metal structures for the application. The variety of structures ranges from randomly laid fleeces to regular webs to highly orientated textures, including fringed fabric sections or Velcro-like fasteners.

Potential fields of application are being considered for heat exchanger components that require high porosity, high surface to volume ratios, and good thermal conductivity. Examples include evaporator structures or carriers for thermal active materials, such as adsorption materials (zeolites, metal-organic scaffolding), or latent heat storage (PCM). Other possible fields of application can be found in chemical plants, such as for the evaporation and condensation of chemicals.

- 1 Detailed image of a sintered fleece made of copper hollow fibers.
- 2 Flat tube with partly fringed woven copper hollow fibers sintered on top.

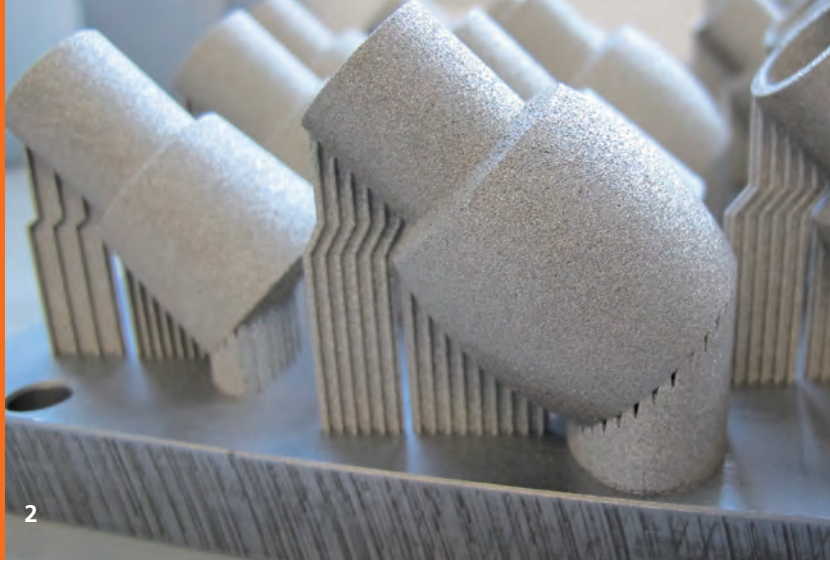
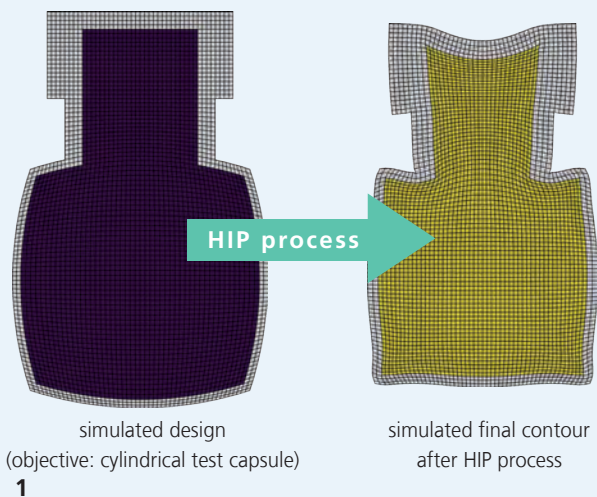

EFFICIENT PROCESSES FOR THE PRODUCTION OF COMPLEX SHAPES

In order to enable the production of components with complex shapes and with an integrated functional layer (e.g. protection against corrosion or wear), the project “Complex Shaped Net-Shape Composite Components using HIP and Additive Manufacturing” combines laser beam melting (LBM) and hot isostatic pressing (HIP) for the production of near-net-shape composite components.

Through the HIP process, components with isotropic properties and the theoretical density of the material can be produced from powder, so that these can be used in the industrial production of high-load monolithic parts, such as in aircraft engines, the offshore sector, and to protect against wear. The complexity of the necessary capsules has thus far been limited by the processes used to produce them. The LBM process enables the production of metal capsules with complex forms and with little effort, and thus has the potential to significantly simplify the powder-HIP process and reduce post-processing costs. If the capsule is made from a functional material that subsequently remains as a surface layer on the component, then composite components are created. These consist, for example, of a core with high strength and toughness and an outer layer of a corrosion or wear-resistant material.

The challenges of this project arise from the significant changes in volume of 20 to 30 percent that occur during the HIP process. Using FEM simulation, this defect can be predicted and addressed, allowing for a corresponding capsule design which results in a near-net-shape production (Fig. 1). Another challenge is material processing into gas-tight capsules by means of LBM. Particularly regarding the laser melting of wear-resistant materials, there have been few experimental studies. Due to their hardness and low toughness, these materials tend to crack as a result of internal tensions. Suitable materials regarding the expected functionality and

processability as well as the availability of powders were determined by the committee that accompanied the project.

For the corrosion-resistant material 316L and the quenched and tempered steel 56NiCrMoV7, the optimization of the process parameters, in particular scanning speed and laser power, has been successfully completed. Thus, first capsules could be made (Fig. 2), which are filled with powder and successfully put through hot isostatic pressing. Similar to the other materials, for the high-carbide steel FeCrV10 cubes should first be produced using varied laser power and scanning speed. Only with additional plate heating (300°C) was it possible to produce cubes with the desired height of 5 millimeters. However, as this led to severe cracking, various amounts of a low-carbon ferritic steel (X6Cr17) had to be added to increase the ductility of the matrix phase. Powder mixes with an X6Cr17 content of 25% allowed crack-free cubes to be successfully built and metallographically examined.

Participating research institutes (IGF-Vorhaben 18968 N, July 2016–Dec. 2018): Fraunhofer IFAM; RWTH Aachen.

- 1 Prediction of the defects due to the HIP process using a simple cylindrical test capsule.
- 2 HIP capsules made of 316L with a support structure built using LBM.

ELECTROMOBILITY



CORE COMPETENCE ELECTROMOBILITY

Electrically operated systems play a central role in all sectors of industry. The supply and efficient use of electrical energy in complex technical systems requires a comprehensive understanding of the system as a whole. Based on the electrical and electrochemical properties of materials, Fraunhofer IFAM is developing technical solutions for the efficient use of electrical energy in mobility applications, including cars and commercial vehicles as well as aircraft and ships.

The safe storage of electrical energy with a high energy density and power is a constant challenge and plays an important role particularly for mobility applications. Aspects of materials and process technology are at the forefront of the efforts by Fraunhofer IFAM to develop solutions for future electrochemical energy storage systems. In addition to lithium-ion batteries, the focus is increasingly turning to solid-state batteries, using ion-conductive ceramics or polymers in a solid phase in place of a liquid electrolyte. This is where the material and manufacturing competences of IFAM are systematically applied to the required material and process development. The process chain, meanwhile, can also be developed from the powder to the finished battery cell for customer-specific materials. The storage of hydrogen as an energy carrier using metal hybrid technology is another important aspect.

Electric drive technology focuses on the development, prototype construction, and testing of highly efficient electric machines. In addition, new approaches to increase the functional safety of drive systems as well as efficiency-optimized control, in particular of permanently energized synchronous machines, are being developed. At the forefront are the increase in power and torque density as well as the development of special manufacturing techniques for electric drives. In order to evaluate and increase their operation performance, individual components – such as the electric drive train – are evaluated on a test rig. Adhesive bonding technology, surface technology, and coatings complement the

core competence with such aspects as the joining, contacting, insulating, and protection of electrically conductive materials.

An important building block in this concept is the analysis and evaluation of complex technical energy systems – ideally with the integration of electric vehicles as mobile storage units. The coupling of electrical systems with the heating supply at the local (house/block) and regional levels requires the use of heat and electrochemical storage and transformers. To this end, Fraunhofer IFAM offers training programs that take into account the economic and current regulatory framework conditions of the electricity and heat markets.

Finally, the inclusion of mobile and stationary storage units in house energy systems is modelled for the optimization of energy efficiency and/or energy self-sufficiency and simulated at a modular test facility with actual components.

> www.ifam.fraunhofer.de/electromobility

1 *Lightweight construction and vehicle concepts – from the development to the training.*

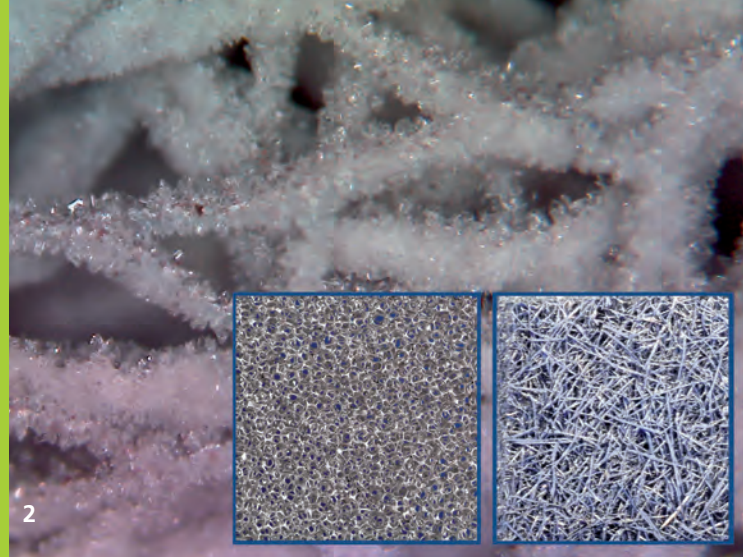
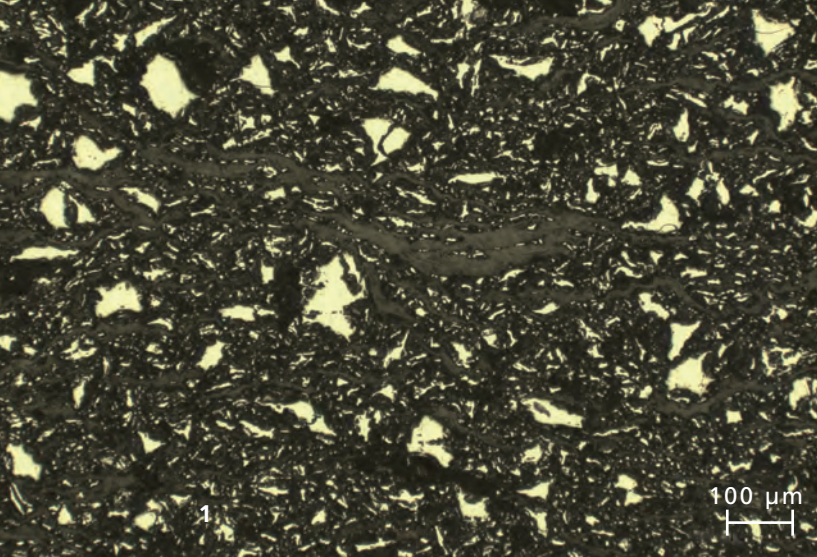

NEW APPROACHES TO POWDER METALLURGY: GAS-SOLID ENERGY STORAGE

Energy stores for fuels (chemical) and heat (thermal) are among the most important components of efficient energy systems for stationary and mobile applications. At the Fraunhofer IFAM Dresden branch, capacity and performance-optimized chemical and thermal energy storage systems based on powder metallurgical production processes are being developed that make use of the special properties of gas-solid systems.

As a fuel, hydrogen (H_2) has the highest possible gravimetric energy density and can be produced by a variety of processes, such as the electrolysis of water when there is a surplus of electrical energy. In mobile applications with hydrogen-powered fuel cells especially, the minimization of the storage size requires a high volumetric storage density in conjunction with a preferably low pressure (safety).

These requirements are met by so-called hydride storage systems, in which gaseous hydrogen is stored in a metallic solid via a chemical reaction. Such metallic solids can be produced with powder-metallurgical methods. This has the advantage that specific additives can be finely dispersed in the solid in order to meet further requirements that are placed on the storage material, such as a rapid heat and gas transport. The development of these so-called metal hydride composite materials (Fig. 1) has shown that various natural graphites are suitable additives, simultaneously achieving a very high thermal conductivity, a defined porosity, and the desired density.

Based on such a gas-solid system, thermochemical heat accumulators can also be developed that guarantee a high storage density (up to 1000 kWh/m^3) and minimum losses. The charging/discharging of the storage systems is carried out via

endo/exothermal chemical reactions for the separation/binding of the material system. In addition to H_2 as a gaseous component, water vapor (H_2O) can also be used for the formation of salt hydrates made of metal salts.

In order to achieve optimum storage parameters, powder metallurgy also offers innovative development approaches in the form of cellular metals (foams, fibers, and wires). While the storage capacity depends directly on the reaction heat of the reacting material, the storage performance is influenced by numerous factors such as the layer thickness of the solid, the gas permeability, or the heat transport properties of the structure.

Building on the extensive know-how of the use of cellular metals in high-performance latent heat storage, a current project¹ is developing highly porous metal-metal salt structures for thermochemical heat storage systems (Fig. 2), which have an extremely high volume-related metal salt surface (storage capacity) on top of a heat-conducting and highly porous – and thus permeable to water vapor – cellular metal structure (storage kinetics).

- 1 *Metal hydride-graphite composite material in cross-section.*
- 2 *Zeolite-coated aluminum fiber structure (same process in principle) and structural images of cellular metals (© SorTech AG).*

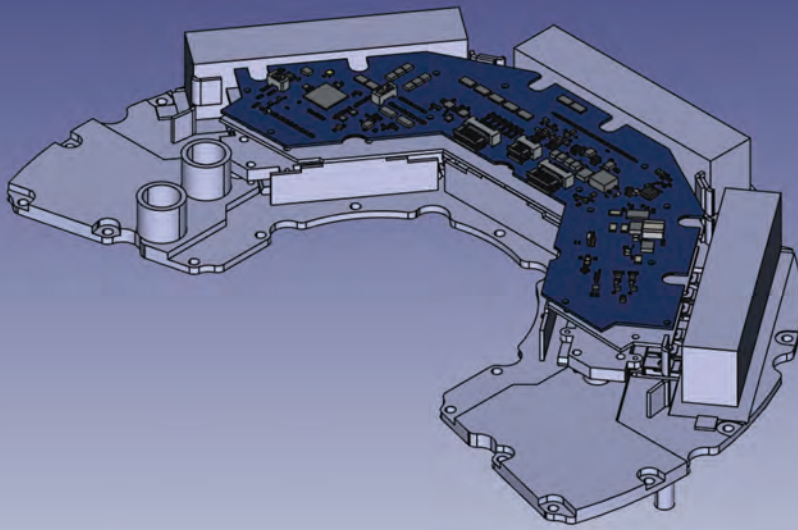

WHEEL HUB DRIVE ENABLES OPTIMUM RECUPERATION

The joint project "RABBIT – Wheel Hub Drive Without Brake/Brake Resistance Integrated Into Thermal Management", sponsored by the Federal Ministry of Economic Affairs and Energy (BMWi), aims to design wheel hub drives that allow for the optimum use of the recuperation potential. To this end, Fraunhofer IFAM is developing an integrated drive controller.

Electromobility is strongly motivated by the decarbonization of transport. This requires, among other things, increasing the entire efficiency of the vehicle in order to move transport as far as possible away from CO₂ emissions in the energy conversion chain. Electric vehicles with wheel hub drives now offer the opportunity to realize vehicles without a mechanical friction braking system at the rear axle. In addition to the CO₂ savings gained through the electrification of the drive train, this concept contributes to the reduction of the emission of fine dust (brake dust) that occurs during braking.

Two wheel hub drives generatively provide the necessary braking power. At the same time, they enable the separate control of the torque at each wheel, which is a prerequisite for certified driving dynamics control systems. In order to safely capture the braking energy at any time, an alternative energy sink is required, which is provided by an electrothermal recuperator in the form of a braking resistor, which enables the braking energy to be used even when the conditions or charge states of the battery system are unfavorable. Supplying the recuperated energy for the thermal management of the entire vehicle contributes to increasing its range.

The challenge of full-recuperative braking lies in the fulfilment of legal regulations and the even stricter requirements of vehicle manufacturers. The project goal of the research project

RABBIT, funded by BMWi since April 2015 and supervised by lead partner DLR, is therefore the development of an electrical drive train with an alternative energy sink that fulfills all these requirements while at the same time enabling the electrical and thermal use of the energy incurred during braking. In addition to Fraunhofer IFAM, the participants in the RABBIT project are Schaeffler AG (consortium leader), Continental AG, and Ford AG as well as the Leibniz University of Hannover.

Focus of the work at Fraunhofer IFAM is the development and prototypical construction of a wheel hub drive-integrated drive controller. This control device forms the interface between the power section of the wheel hub drive and the rest of the vehicle. The main challenges lie in the design tailored to the specific assembly space and in the solutions for multi-phase drive systems.

1 CAD model of the integrated drive controller (ECU).

AUTOMATION AND DIGITIZATION

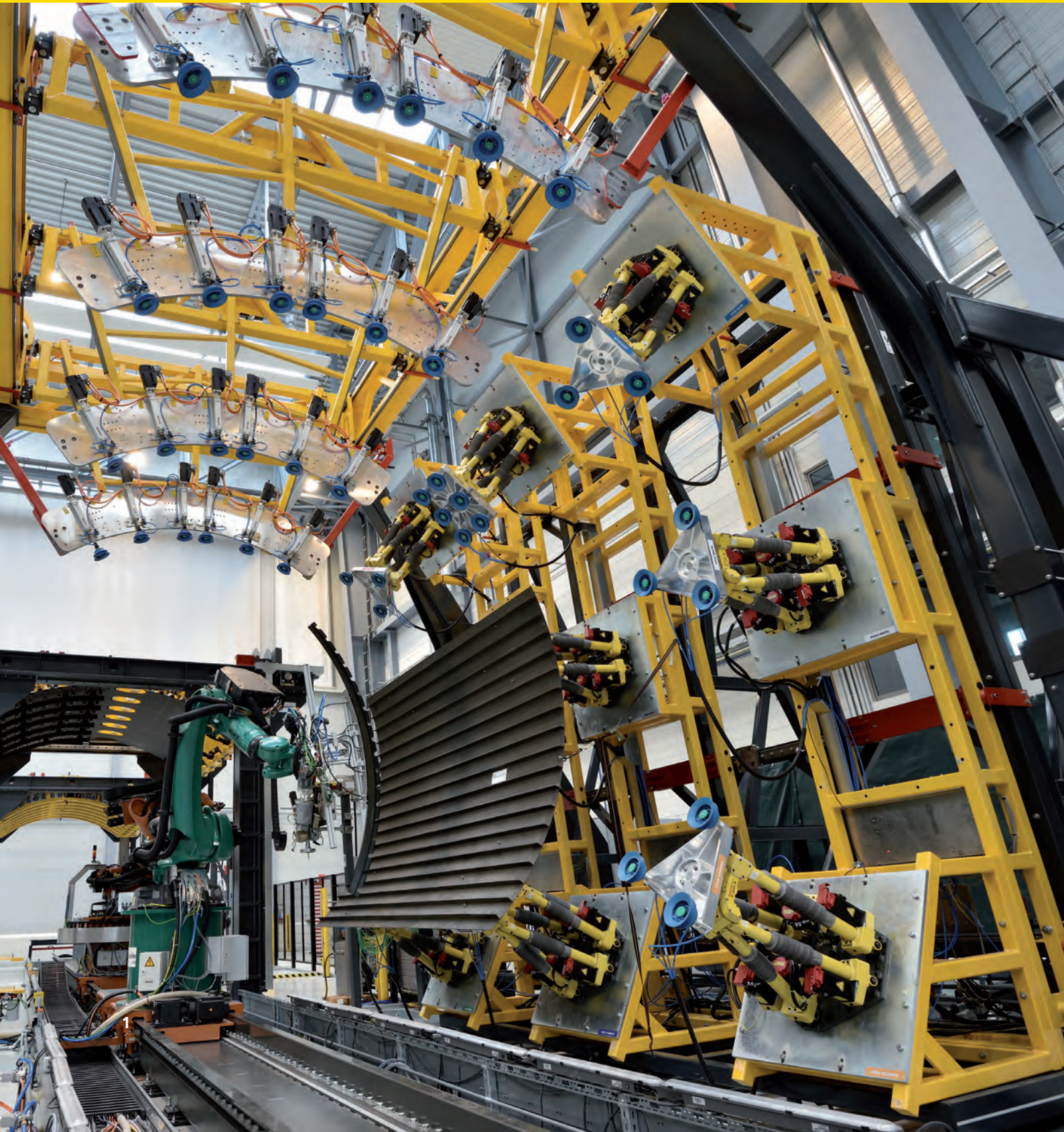

CORE COMPETENCE AUTOMATION AND DIGITALIZATION

In addition to the diverse materials science and process engineering research activities, the research into the field of the key technologies of automation and digitalization completes the competence spectrum of Fraunhofer IFAM. The focus here is mainly on processes that need to adapt constantly and with great precision to components with low shape accuracy as well as changing production processes and human participation in the production.

This core competence encompasses IFAM's key areas within the categories of joining, sealing, surface treatment, processing, and printing, including the interaction with a digitized production environment (Internet of Things, Big Data), as well as queries stemming from customers or project partners in the context of joint projects. Here, solutions are being developed for a holistic quality assurance of production processes, materials, material composites, and coatings through the use of innovative methods to capture, evaluate, and visualize measurement data as well as the use of intelligent materials.

The automation and digitalization solutions of Fraunhofer IFAM serve to increase the effectiveness and efficiency of manufacturing and repair processes, improve ergonomics and work safety in production, optimize the product lifecycle by monitoring both quality and conditions, improve product quality, and reduce process costs.

Fast and quality-assured processes are essential for series production. Fraunhofer IFAM offers automation solutions that can recognize components as well as tolerances, even in very large lightweight structures with low dimensional stability, and adapt to them individually and with high precision. With the motto "precision through measurement technology and sensors instead of heavy steel construction", Fraunhofer IFAM

attaches particular importance to lightweight, mobile, and modular system components that can be linked to highly versatile production systems via Industry 4.0 architecture.

An overarching competence component is quality assurance – in the manufacture, assembly, and repair of components and structures. The continuous monitoring of the condition of component surfaces through customized inspection methods is an essential goal in the optimization of application-specific manufacturing processes. This is supported by a range of comprehensive training programs that cover multiple products and branches of industry for the certification of personnel, during which a technology transfer takes place, bringing scientific knowledge and methods into industrial application.

> www.ifam.fraunhofer.de/automation-digitalization

1 *Assembly plant for aircraft hulls with flexible imagery to correct the shape and position of large components.*

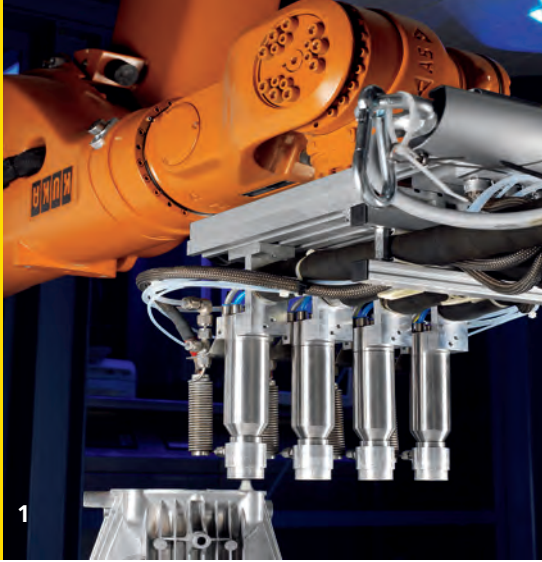

1

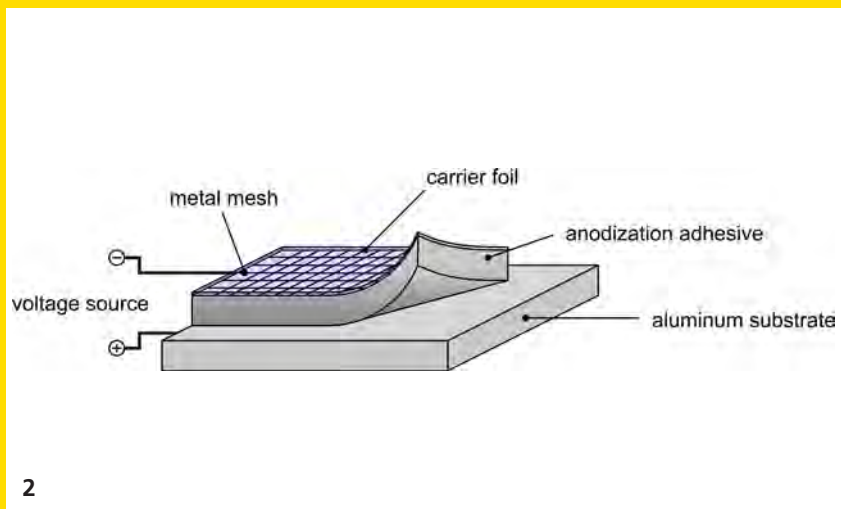

2

INNOVATION IN FIBER-METAL LAMINATE (FML) PRODUCTION FOR AIRCRAFT CONSTRUCTION

Besides the ongoing efforts of the aerospace industry to reduce fuel consumption through advanced light-weight construction concepts for new aircraft structures, the need for a resource-efficient and cost-effective processing of the materials used during aircraft manufacture is increasingly becoming the focus of developments. Both goals can be achieved through the use of modern fiber-metal laminate components (FML) in combination with new automated manufacturing processes. For this purpose, the current research project “NFM-GLARE”, as part of the Aerospace Research Program V-II, will cover various aspects of the surface treatment of thin aluminum sheets used in FML production as well as the automation of individual manufacturing steps.

Surface treatment of aluminum sheets

Aluminum sheets used for FML components in aircraft construction are currently protected against corrosion by a combination of anodization (phosphoric sulfuric acid anodizing, PSA) and the application of a chromate loaded adhesive primer. Furthermore, the outer aluminum sheets are covered by an additional coating consisting of a primer and a top coat. At the cutting edges, local corrosion protection measures are used in the form of manually applied chromate loaded conversion coatings. For the thin aluminum sheets used in FML production, alternative pre-treatment techniques for corrosion protection and to achieve the necessary adhesion properties were tested in the above-mentioned project, investigating laser, plasma, and anodizing tape techniques. In view of the required corrosion protection and adhesive strength, these methods were compared with the current production method, i.e. the anodization of aluminum sheets via the PSA process. Suitable parameters for the treatment of various sheet thicknesses were evaluated for atmospheric pressure plasma technology in order to minimize the heat-induced deformation

of the thin sheets. Based on this, for corrosion protection, suitable plasma polymer coatings on a silicon organic basis with appropriate barrier properties against corrosive media were chosen. Overall, the results showed that the aluminum sheets, which are delivered in an undefined surface condition, must first be treated with an ablative process in order to subsequently conduct the suitable plasma treatment that leads to improved adhesion and corrosion resistance.

The anodizing tape enables a dry surface pre-treatment of aluminum parts during production or as a local application. All components required for anodization are integrated into the functional tape. As the tape can be removed without residue, subsequent cleaning processes are simplified, which is advantageous in the case of rework or repair. It could be shown that the anodizing tape forms structured oxide layers on the sheet materials of the aluminum alloy AA2024. The oxide morphology is comparable to that of the PSA oxide, which allows a good adhesion performance of the adhesive primer or the adhesive. In addition, initial tests on local sur-

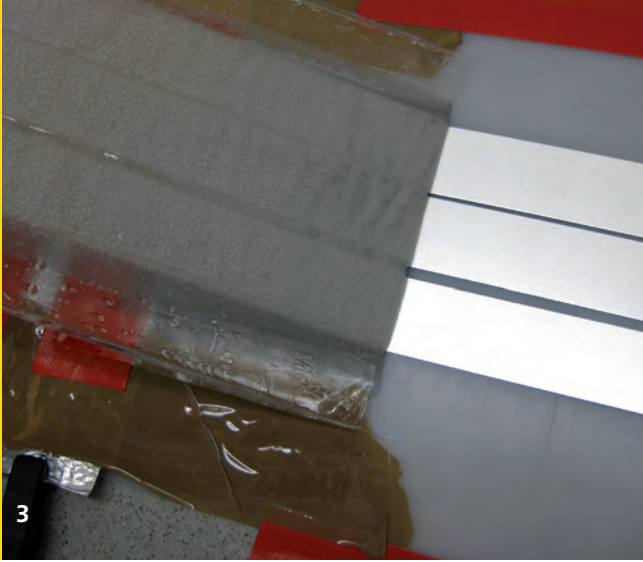

3

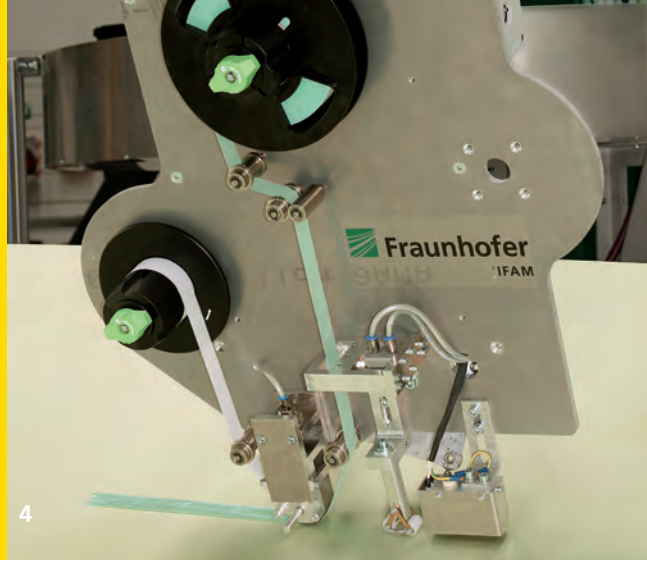

4

face treatments for adhesive repair concepts of FML skin fields were undertaken.

The resulting adhesion properties of all investigated non-bath processes meet, at the current state of development, the basic aircraft requirements. For industrial use, however, additional properties must first be tested or validated, such as the fatigue behavior and the corrosion resistance of adhesively bonded joints.

Automated FML manufacture

The construction of FML laminate occurs through the manual alternate deposition of thin aluminum sheets and fiberglass prepregs with different fiber orientations. FML shells are composed of smaller sheets, where the edges are connected by splices with alternating overlaps of aluminum and glass fiber layers. Interlaminar aluminum doublers serve as gap holders, while tape strips fix the components and fill the cavities created by the offset layer. To stiffen the shells, aluminum stringers are placed onto the uncured FML and an adhesive film is manually applied to the base of the stringer to secure it against slipping.

One of the objectives of the NFM-GLARE project is the automation of the previously manually executed application of adhesive tape strips and stringers. The developed end effector for automated adhesive film application meets a wide range of special requirements. In robotic operations, its weight is below 100 kg, including a module that allows automated tool change. Its orientation refers to the deposition tooling and it calculates the exact tracks onto which the tape is to be placed. In order to ensure a precise application, it actively drives the tape from the inserted supply roll, separates it from both the liner above and the carrier paper beneath, cuts it with a clean edge without damaging the carrier paper, and pressures it onto the laminate with a pressure roller. This allows tape strips of any length to be applied, even onto uneven laminate surfaces in cylindrical or spherical areas of the FML shells. An infrared unit integrated into the end effector

ensures the adhesion of the adhesive tape, irrespective of the ambient conditions. The range of services is completed by an automatic monitoring of the filling level, pressure, process temperature, and applied tape lengths.

The tape can also be used to attach the aluminum stringers, which, due to their length of six meters, are deposited by two cooperating robots. The specifically constructed roll grippers enable the necessary longitudinal movement of the stringers as well as the fine control of pressure and local heating for precise attachment.

Customer

The collaborative research project NFM-GLARE is supported by the Federal Ministry of Economic Affairs and Energy within the framework of the Aerospace Research Program V-II, funding number 20W1517D; duration of the initiative: Sep. 1, 2015 - Aug. 31, 2018.

- 1 Atmospheric pressure plasma technology: Nozzle array for automated robot-guided treatment.
- 2 Anodizing tape; schematic sketch of the application principle.
- 3 Anodizing tape; peeling off the anodizing tape following anodization.
- 4 Adhesive film end effector for automated deposition of tapes.

PEOPLE AND MOMENTS



NEW BUSINESS SEGMENT POOLS CORE COMPETENCES FOR MARITIME TECHNOLOGIES

For many years, Fraunhofer IFAM has been active in research and development in the fields of corrosion protection, functional coatings, and adhesive bonding in the shipbuilding industry. Considerable development work has already been carried out in a wide variety of public and bilateral projects. The institute's scientists anticipate that in the near future there will be a further developmental thrust in this field of technology. However, research is a lengthy process, and there are often many years between the first idea and the market entry. Within this new business segment, all activities of the institute will be pooled in order to identify future requirements and coordinate development goals.

The maritime economy is one of the most important industries in Germany, especially in the state of Bremen. In order to secure and expand this very productive industry, the highest level of products and services are required.

As a material science research institute, the key areas at Fraunhofer IFAM, such as anti-corrosion and anti-fouling coatings, surfaces that reduce flow resistance, adhesive manufacturing in shipbuilding, and lightweight construction, are the main pillars in this sector. However, such topics as the electrification of ship drives and electrical energy reservoirs for surface and underwater applications are increasingly gaining importance. In addition, Industry 4.0 is opening up new manufacturing opportunities for the industry as well as other maritime business areas.

In addition to the conventional development work in a technical lab, the testing of new technologies under real-world conditions is very important for the maritime industry. For this purpose, the institute operates various test rigs under the auspices of its own scientists. In List on Sylt, at the "Alte Weser" lighthouse, and on the offshore island of Helgoland, a total of

several hundred samples can be tested for anti-corrosion and anti-fouling properties in the underwater zone, in the tidal zone, in the splash zone, and on land. In cooperation with several industrial and research partners, work is being conducted on the implementation of further offshore testing facilities. For public research projects as well as customer orders, the new business segment of maritime technologies offers ideal capacities and testing opportunities for maritime applications.

1 Test facility "Alte Weser" lighthouse, with corrosion samples in the coastal shipping area.



FRAUNHOFER BUILDS NEW PROJECT CENTER FOR ENERGY STORAGE RESEARCH

With the support of the state of Lower Saxony, the Fraunhofer-Gesellschaft is establishing the Fraunhofer Project Center for Energy Storage and Systems in the Braunschweig area as a joint research platform of two institutes, namely the Fraunhofer Institute for Ceramic Technologies and Systems IKTS and the Fraunhofer Institute for Manufacturing Technology and Advanced Materials IFAM, in close cooperation with the Battery LabFactory Braunschweig (BLB) at the Technische Universität Braunschweig.

The aim of the Fraunhofer Project Center is to develop system solutions for batteries and fuel cells in the area of electromobility as well as for stationary storage as part of the shift towards renewable energy. For this purpose, intensive cooperation is being promoted between several Fraunhofer Institutes and the research facilities of the Technische Universität Braunschweig in order to pool and expand the know-how particularly on material, production, and system technology, both for and with the industry.

“Lower Saxony is tackling the questions of future mobility: New vehicle concepts, autonomous driving, and alternative drive technologies are the current challenges in vehicle construction. We stand for efficient and climate-saving answers through modern mobility research. The development of the joint project center further extends the strengths of the TU Braunschweig together with the Fraunhofer partner,” says Gabriele Heinen-Kljajić, Minister for Science and Culture for the State of Lower Saxony.

Prof. Reimund Neugebauer, President of the Fraunhofer-Gesellschaft, adds “In the development of next-generation batteries, there is a unique opportunity for Germany to

return to the top of this strategically important technology. If it succeeds, an important contribution will be made to securing qualified jobs in production and development. Together with our partners, we today set our mark and activate our enormous innovation potential for tomorrow.”

Within the framework of the project center, using an interdisciplinary approach, the entire value chain is to be developed for both mobile and stationary storage technology, from the raw materials to the components, including the process and production technology as well as quality assurance and system integration. In this field of research, the Fraunhofer Project Center for Energy Storage and Systems is synergistically embedded into the existing research structure at Fraunhofer.

1 *Gabriele Heinen-Kljajić, Minister for Science and Culture for the State of Lower Saxony (in office until November 2017), Prof. Jürgen Hesselbach, President Technische Universität Braunschweig (in office until April 2017), and Prof. Reimund Neugebauer, President of the Fraunhofer-Gesellschaft at the signing of the agreement for the project center.*



AUTOMATED VERTICAL TAIL PLANE ASSEMBLY AWARDED

In May 2017 at the 11th CFK Valley Convention, the experts for automation and production technology at Fraunhofer IFAM, representing the project consortium “FlexMont”, were honored by the CFK Valley Innovation Award 2017 for the first automated assembly of aircraft vertical tail planes using carbon fiber reinforced plastics (CFRP) in the presence of more than 300 visitors from 20 nations in Stade.

Representing the project consortium, Dr. Dirk Niermann, head of the Automation and Production Technology Department at Fraunhofer IFAM at the Research Center CFK NORD accepted the prize of €7500, endowed by the Hanseatic City of Stade, from Prof. Dr.-Ing. Axel Herrmann, Managing Director of the Composite Technology Center CTC, Stade, and Thomas Friedrichs, head of Administrative Department Economic Development, Stade. Together with the project manager Fabian Ehmke, Fraunhofer IFAM, and group manager Dr.-Ing. Gregor Graßl, Fraunhofer IFAM, as well as the project partners Airbus Deutschland, CTC GmbH, FFT Produktionssysteme GmbH & Co. KG, Mahr Metering Systems, and QUISS AG he was overjoyed at the recognition of their cooperative efforts.

The decisive factor in winning the CFK Valley Innovation Award 2017 was the fact that the FlexMont project has achieved its goal at an important stage on the diverse and extremely demanding path of moving from manual assembly to an industrially viable and cost-reducing automation solution, encompassing many special developments.

The aim of the FlexMont joint project, which was funded by the Lower Saxony Ministry of Economic Affairs, Labour, and Transport, was a significant reduction in assembly times and costs for the CFRP box of the vertical tail plane on the A320 aircraft series. As a concrete example, a groundbreaking box design (VTP-NG) was used to support the automation of the assembly process. The special features of the design solution include side shells made of a CFRP sandwich, which are stiff-

ened on the inside of the box with eight horizontal half-ribs with a double T-profile. When the box is closed, geometric tolerances accumulate inwards at the distance of the half-ribs, which run towards each other at sharp angles. The resulting gap is closed with an individually 3D-printed thrust wedge.

The automation process includes

- 1 the automatic adhesive bonding of the half-ribs onto the shells using a two-part multifunctional grabber with an attachment unit on the robot.
- 2 closing the box with a front and rear spar in a box assembly station by means of a compression unit and a lightweight construction robot that is navigated by an industrial robot as end effector.
- 3 the sealing of aerodynamic seams on the outside sections with a hand applicator.
- 4 automated processes for the sealing of rivet heads and irregular wide and deep gaps between part edges as well as a robot-guided camera system for quality assurance inspection.

1 *Awarding of the project consortium “FlexMont” with the CFK Valley Innovation Award 2017 – Thomas Friedrichs, head Administrative department Economic Development Stadt Stade, Dr. Gunnar Merz, CFK Valley, Prof. Dr.-Ing. Axel Herrmann, CTC, Dr.-Ing. Gregor Graßl, Fraunhofer IFAM, Dr. Dirk Niermann, Fraunhofer IFAM, Christophe Korth, FFT Produktionssysteme GmbH & Co. KG, Fabian Ehmke, Fraunhofer IFAM, Joachim Piepenbrock, CTC, and Dr. Lars Fiedler, Airbus Operations (left to right; © CFK Valley e. V.).*

2 *Station for the box assembly with a press unit at CFK NORD, Stade.*



FIRST COMPOSITE ENGINEERS CERTIFIED

After 240 hours of training and having successfully passed their exams, the world's first "composite engineers" were able to proudly hold up their certificates in August 2017. The modular program to become a composite engineer now qualifies the participants to be responsible for the entire lifecycle of a component made of fiber reinforced materials, from product development and manufacturing to repair. This holistic qualification is internationally unique and complements the comprehensive training in fiber composite materials offered by the Fraunhofer Institute for Manufacturing Technology and Advanced Materials IFAM in Bremen.

Since 2007, through its Training Center for Fiber Composite Technology, Fraunhofer IFAM has been providing employees from the industry and trade sectors with qualifications for various target groups in the field of fiber composite technology. The training program is constantly being adapted and further developed to meet the current requirements of companies as well as technological progress. With the ability to qualify as a "composite engineer", all hierarchical levels of a business – from the worker to the master/foreman to the decision-maker – can now enjoy further career development in the fiber composite sector at Fraunhofer IFAM. At the end of the course, participants are able to supervise the entire product lifecycle of a component made of fiber reinforced materials and can interdisciplinarily assess the correct use of the technology.

In order to ensure a comprehensive and direct knowledge and technology transfer, the Fraunhofer-Gesellschaft bundles the competences of fiber composite materials into the Fraunhofer Lightweight Design Alliance. The courses are designed and implemented in conjunction with this alliance. Participants in this course have the certainty of being both comprehensively trained by experts as well as continuously updated regarding research and development in the various fiber-related subject areas.

The main focus of the alliance is the research and development of procedures for the realization and assessment of lightweight elements in order to meet safety requirements. With increasing exploitation of technical systems, there is the risk that conventional assessments of the suitability of lightweight construction systems will lead to errors. In particular, a lack of knowledge regarding real operating conditions, loads, etc. that occur during operation can, depending on the material, lead to incorrect load assumptions – and thus to failure during operation. The ability to make this assessment is just one of the benefits of the course.

1 Prof. Dr. Bernd Mayer (2nd row, center) hands over the highly desired certificates to the world's first "composite engineers".



NEW SEMINAR FOR ADHESIVE BONDING MANUFACTURE

On September 12 and 13, 2017, the Adhesives Manufacturing Industry Meeting was first held at Fraunhofer IFAM. The industry meeting is a new conference format that focuses on adhesive bonding as a technology for the industrial manufacture of products. The event is aimed at users and manufacturers of adhesive production systems, covering such topics as production-oriented adhesive selection, adhesive processing, process automation, economical process chains, and quality assurance.

Renowned manufacturers of automatic dosing and application technologies, innovative users of adhesive manufacturing, and research institutes all contributed to the event through presentations. The technical presentations on such subjects as current challenges of adhesive technology, application examples from automobile production, rail vehicle construction, micro-bonding, or heavy steel structures all gave various insights and summarized the state of the art in a real-world context accompanied by an analysis of current development trends. They also gave an account of the challenges of introducing the DIN 2304 standard into user operations.

The quality of adhesively bonded products is significantly determined by the adhesive process. New materials and mixed constructions combined with the highest demands on joining have made adhesives the preferred joining technology, especially in high-tech areas. For its part, adhesive technology places high demands on the user as, irrespective of the industry in which the adhesive technology is used, the process chain and manufacturing technology must be safely controlled.

Networking in a pleasant atmosphere were facilitated by both a comfortable time schedule and an evening event, while the adjoining exhibitor forum enabled in-depth individual discussions. The next industry meeting will take place in autumn 2019.



FABIO LA MANTIA RECEIVES ERC CONSOLIDATOR GRANT

In November 2017, there was a special reason for joy at the University of Bremen and at the Fraunhofer Institute for Manufacturing Technology and Advanced Materials IFAM: Fabio La Mantia, professor in the Department of Production Technology and expert in the field of battery research, received the ERC Consolidator grant, one of the highest endowed personal awards from the European Research Council.

The use of renewable energy from wind or water is becoming increasingly important. Knowledge about the conversion of chemical to electrical energy is also necessary, for example, for the development of more efficient battery storage systems. La Mantia will therefore use the grant primarily for fundamental research in the field of "EllonT" (Electron and Ion Transfer at the Interface: A Hyphenated Dynamic Multi-Frequency Approach). He intends to investigate how advanced analytical methods, modeling, and precise experimental designs can be combined to better investigate the effect of non-ideal particle interactions in the process of charge transfer at the solid-liquid interface. This process is the basis of all electrochemical systems, including fuel cells, electrolyzers, and batteries, which are at the center of discussions regarding the shift towards renewable energy. Understanding such interactions would allow the design and development of improved systems.

The aim of this project is to extend the ideal theory of charge transfer to the real world, that is, the necessary research of electrochemical interactions. "The five-year grant from the ERC is a wonderful opportunity to implement my research idea together with my research group. With the additional resources, we can carry out the complex experiments much faster and to a much greater extent. The conditions that result from the cooperation between the Department of Production Technology at the University of

Bremen with Fraunhofer IFAM are optimal for this," says La Mantia.

The ERC Consolidator grant is one of the European Union's highest endowed support instruments for individual researchers. Through this, the European Research Council supports excellent young researchers who are at the beginning of an independent research career.

La Mantia completed his master's degree in chemical engineering at the University of Palermo (Italy) and received a doctorate in 2004 from ETH Zurich and the Paul Scherrer Institute (Switzerland). At the University of Bremen, La Mantia holds an interdisciplinary professorship in the subject of energy storage and power converter systems at the Department of Production Technology – Mechanical Engineering and Process Engineering. In cooperation with Fraunhofer IFAM, he continues his research on aqueous zinc-ion batteries, the recovery of energy from saltwater and heat, and the modeling of electrochemical systems. His research objective is, among other things, the development of batteries with longer service life for stationary applications in the industry.

1 Fabio La Mantia. © University of Bremen

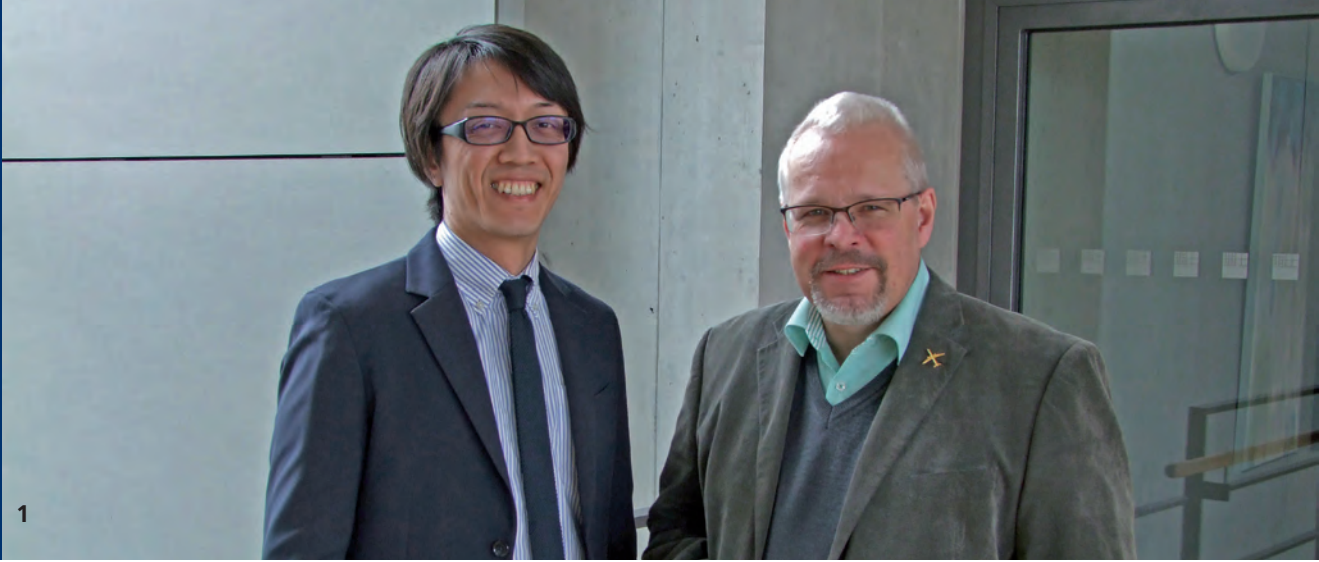

NETWORK PROJECT ENHANCES COOPERATION BETWEEN JAXA AND FRAUNHOFER

Japanese scientists and engineers recognize a growing need for application-oriented research and industry-oriented approaches in order to overcome the “valley of death” during the conversion of research results into innovations. For several years, the Fraunhofer model of applied research has been used in Japan as a template for an effective research environment. Fraunhofer is already successfully active in Japan and is striving to further deepen its relationship with the country’s research and industry sectors.

Against this backdrop, a project was jointly initiated by JAXA (Japan Aerospace Exploration Agency) and Fraunhofer IFAM to achieve two goals: On the one hand, the creation of a permanent network between JAXA and Fraunhofer for future joint projects, also with the involvement of other partners, and on the other hand, the building of a good understanding of the two research environments in order to derive improvement opportunities from proven practice.

The network project SEACASP (Staff Exchange Aiming at Future Collaboration in AeroSpace Projects) included the one-year posting of a JAXA researcher to Fraunhofer IFAM and his close involvement in the daily work. In addition, visits to other Fraunhofer facilities as well as various trade fairs and conferences are also planned.

Hiroshi Nakayama made his mark during the selection of candidates. He began at JAXA first as an architect for land-based aerospace infrastructure, then worked in the planning of satellite missions before moving to the staff department of business development, where he is responsible for the support of the Japanese space industry. SEACASP began under the direction of Gerhard Pauly in November 2017 with

the arrival of Hiroshi Nakayama in Bremen. He is working with EU applications under HORIZON 2020 and specifically in the EU project RADIANT. First visits to the Fraunhofer Headquarters and Fraunhofer IWS as well as participation at the annual meeting of the Fraunhofer Space Alliance have already provided him with an insight into the manifold work at Fraunhofer.

“I think one of the reasons why the innovation at Fraunhofer is continuous is the framework in which one can contribute their talent and support researchers. One can concentrate on research and career, so that after a few years, well-trained experts with talent and experience can switch from science to industry. In this way, they contribute to the excellent results and the worldwide distinguished reputation of the German industry. For me, it is unique that needs and requirements are captured from the market and are translated into technical applications. This creates a network of research and industry that spans the valley of death.”

1 *Hiroshi Nakayama, JAXA, and Gerhard Pauly, Fraunhofer IFAM, work closely together in the network project SEACASP.*



FUTUREAM – NEXT GENERATION ADDITIVE MANUFACTURING

On November 14, 2017 in Aachen, under the leadership of the Fraunhofer Institute for Laser Technology ILT, the Fraunhofer focus project futureAM was initiated. Six project partners – the Fraunhofer Institutes ILT, IWS, IWU, IGD, and IFAM as well as LZN Laser Center Nord – have set themselves a clear goal: In the next three years, they want to work closely together to meet the prerequisites for significant technological leaps in the field of additive manufacturing with metallic materials (metal AM).

A concrete goal of the focus project is significantly accelerating the additive production of metal components while at the same time reducing production costs. The current restrictions on size are also to be lifted with novel plant concepts. “The research platform is designed to develop new digital process chains, scalable and robust AM processes, systems engineering and automation, as well as a range of processable and affordable materials,” explains Prof. Johannes Henrich, coordinator of futureAM and director of Additive Manufacturing and Functional Layers at Fraunhofer ILT in Aachen.

Alliances in the field of 3D printing are not uncommon, but the futureAM platform differs above all in one point: It is characterized by a close proximity to practice, which is based on the many years of experiences of the participating institutes with metal AM. The complete digitalization of the metal AM process chain, new materials, innovative design possibilities, and a production process accelerated by a factor of ten are the targets. To this end, the six project partners are cooperating in a virtual lab with a cohesive digital representation of the competences and equipment of the participating institutes. Each entity, whether machine or product, is assigned to a “digital twin”. Based on these digital twins, real systems can be optimized using modelling and simulation. This is used, for example, for fault diagnosis,

predictive analysis, or product and process optimization. The role of human beings is shifting from the central planning of today to decision-making and monitoring. Autonomous systems within the virtual laboratory support people in a locality through appropriate evaluation and monitoring tools. The virtual lab thus also provides complete digital transparency.

The researchers of the participating institutes cooperate in an interdisciplinary manner. The practical suitability of the innovative developments is to be demonstrated by means of concrete components. Within this project, Fraunhofer IFAM is working together with IWD in Dresden on a reinforcing structure made from a second high-strength material.

1 *Partners from industry and research met in Aachen on November 14 to kick-off the Fraunhofer focus project futureAM.*
© Fraunhofer ILT, Aachen / Andreas Steindl



DAY OF LIGHTWEIGHT CONSTRUCTION IN STADE – A MARKET FOR FUTURE TECHNOLOGIES

Since 2009, the experts for automation and production technology at Fraunhofer IFAM in Stade, together with more than 50 companies, have been exploring and developing new production technologies for large aerospace structures made of carbon fiber reinforced plastics (CFRP). In order to bring the globally leading results into industrial applications that extend beyond aircraft construction, a newly conceived event took place on November 15, 2017 at the Research Center CFK NORD in Stade.

On the initiative of the Lower Saxony Ministry of Economic Affairs, Labour, and Transport, the Fraunhofer-Gesellschaft and the German Aerospace Center (DLR) organized an industry-wide technology exchange in Stade under the motto “Day of Lightweight Construction”. The special part: Unlike conventional conferences, the industry partners involved in the research projects assembled an exclusive list of potential users and received their guests at the Research Center CFK NORD directly at the large production facilities. In this way, decision-makers from various sectors were given an unfiltered insight into technologies that were initially developed for aircraft construction but could be modified relatively quickly for other areas of application.

Ingelore Hering, head of Industry and Maritime Economy in the Lower Saxony Ministry of Economic Affairs, Labour, and Transport, Hannover, and Dr. Alexander Roth, director of technology marketing on the board division of Business Models and Technology Marketing of the Fraunhofer-Gesellschaft, Munich, expressed very positive opinions in their speeches regarding the R&D results already accomplished at Stade and highlighted their potentials for cross-sector national and international industry – in particular with regard to Industry 4.0 and highly versatile production.

The more than 100 guests at the “Day of Lightweight Construction” came from the automotive, shipbuilding, rail vehicle, machine engineering, IT, plastics, and not least aircraft industry

sectors. Lively information exchange and plenty of positive feedback from guests and exhibitors encouraged the intention to hold a follow-up event.

Groundbreaking new technologies

In the context of live demonstrations, the experts for automation and production technology presented joint projects with their partners:

- The world’s most accurate six-axis machining robot on a specially developed automated guided vehicle (AGV) (Siemens AG, Ludwig Schleicher Plant Engineering GmbH & Co. KG, Hexagon Metrology GmbH, and MABI AG).
- The automated assembly of aircraft fuselages as well as vertical tail planes (FFT Produktionssysteme GmbH & Co. KG, BA Composites GmbH, Dassault Systèmes Deutschland GmbH, Carl Kurt Walther GmbH, DOPAG – Hilger U. Kern GmbH, QUISS AG, and Hexcel Composites GmbH).
- A self-navigating large robot that is currently under development and whose task it will be to set up robotic modules for machining or repair on the outside of the aircraft fuselage, where these will attach themselves (FFT Produktionssysteme GmbH & Co. KG and Sick AG).

1 Dr. Dirk Niermann, Fraunhofer IFAM, Ingelore Hering, Lower Saxony Ministry for Economic Affairs, Labour, and Transport, Prof. Dr. Bernd Mayer, Fraunhofer IFAM, and Dr. Alexander Roth, Fraunhofer-Gesellschaft, (left to right), discuss the potential uses of the world’s most accurate six-axis machining robot on a specially developed AGV.

NEW CENTER FOR INLINE SURFACE PRE-TREATMENT INAUGURATED

The new center for inline surface pre-treatment at Fraunhofer IFAM was inaugurated on December 7 with a scientific colloquium. With an area of more than 650 square meters, the technical center offers a wide range of pre-treatment techniques that can be used in production processes for various applications, from plasma technology to the most modern beam and laser processes. With this holistic range, processes can be selected according to demands by industrial and research partners and then optimized for each individual production environment.

Surface pre-treatment is a decisive and quality-determining step when it comes to the adhesive bonding, varnishing, or coating of components. Both through the production process and through the development of the component – whether due to production-related contamination, contamination during storage and transport, or corrosion – the surface texture can change and may no longer be suitable for follow-up processes. Incorrect pre-treatment may result in varying product quality or even in product failure. Pre-treatment technologies that can be used inline and that can also be implemented in existing process chains with low space and investment requirements offer a technically feasible solution, thus avoiding costly production outages.

The researchers in the Plasma Technology and Surfaces department are working on cleaning processes that are adapted to the specific contaminants and materials. Whether metals, plastics, or glass, blasting processes with CO₂ snow or vacuum suction methods can be used for a gentle removal of material as much as ultrafine cleaning or activation with atmospheric pressure plasmas or UV radiation. Laser technology also shows promise, whereby nanostructured coatings can be produced on metals. Even hard-to-coat materials such as titanium can be adhesively

bonded or varnished for long periods of time. These methods are supplemented by the deposition of adhesion promotion layers, which enable a long-term joint even under corrosive loads.

The new center for inline surface pre-treatment is characterized by its variety of different industrial technologies. The range of services reaches from fixed automated systems to transportable solutions for mobile use. For this purpose, self-contained backpack systems have been developed that enable the pre-treatment of, for example, a rotor blade on the high seas or a connecting element in an aircraft hull, or the repair of a foil facade element at dizzying heights. In this way, the right processes can be selected in a flexible and uncomplicated manner according to the customer-specific requirements.

1 *Inauguration of the new center for inline surface pre-treatment at Fraunhofer IFAM in Bremen.*



 **Fraunhofer**
IFAM

Atmosphärendruck-CVD mit TTP: Mechanismus

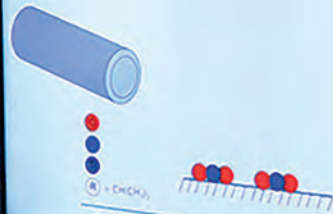

hydrophob
adhesion promotion
anti-bacterial
corrosion protection
decorative coatings
easy-to-clean
cleaning
anti-ice
activation
electrical insulation
release coating

COOPERATIVE AND SCIENTIFIC

Collaboration with universities and technical colleges

Close collaboration and networking with universities and technical colleges are important for Fraunhofer IFAM. We have particularly close links with the University of Bremen and TU Dresden. During the 2015 summer semester and 2015/2016 winter semester, researchers at Fraunhofer IFAM gave over 30 teaching courses at, amongst others, the University of Bremen, TU Dresden, University of Applied Sciences Bremen, and University of Applied Sciences Bremerhaven.

You can find an overview of the lectures and seminars given by employees at the various institutions at:

> www.ifam.fraunhofer.de/vorlesungen

Scientific networks

Last year, over 200 publications documented the R&D work of Fraunhofer IFAM, confirming its strong position within the academic community. This achievement is further emphasized by the awards and prizes bestowed upon the employees of the institute. In 2017, Fraunhofer IFAM scientists participated in a large number of conferences, congresses, trade fairs, and seminars.

In addition to active participation in these events, which were held in Germany and Europe as well as across the world, IFAM

also regularly hosts its own events. A detailed list of scientific publications can be found at:

> www.ifam.fraunhofer.de/veroeffentlichungen

Patents

With the granting of seven patents in 2017, Fraunhofer IFAM is demonstrating the same level of excellence as in previous years. In addition, Fraunhofer IFAM has registered and published 32 patents in the past year. An overview is available at:

> www.ifam.fraunhofer.de/patente

FRAUNHOFER GROUP MATERIALS, COMPONENTS – MATERIALS

For 20 years now, the Fraunhofer Group for Materials and Components – MATERIALS has pooled the expertise of the Fraunhofer Institutes that work in the field of materials science. With more than 2500 scientists and a total budget of approximately €500 million in contract research, it is the largest group within the Fraunhofer-Gesellschaft.

Materials science research within the Fraunhofer-Gesellschaft covers the entire value-creation chain from the development of new materials and improvement of existing materials through to manufacturing technology on a quasi-industrial scale, characterization of properties, and evaluation of applications. The same applies to components and systems made from these materials. In addition to experimental studies in laboratories and pilot plants, numerical simulation and modeling methods are also employed, covering the spectrum from molecules to components and up to complex systems and process simulation. The Fraunhofer Group MATERIALS covers metals, inorganics/non-metals, polymers, renewable raw materials, and semiconductors. In the last few years, hybrid and composite materials have gained in importance.

With the Materials Data Space® (MDS) initiative, founded in 2015, the group has presented a road map for materials compatible with industry 4.0. The group sees an essential prerequisite for the sustainable success of industry 4.0 in the digitalization of materials along the entire value-creation chain.

Key objectives of the group include

- Support for accelerated innovations in the markets of our customers and partners
- Increased success for Industry 4.0 with suitable material concepts (digital twins, Materials Data Space®)
- Increased density of innovation and improvement of usage properties of micro-electronic components and micro-system technology

- Better use of raw materials and improved quality of the products derived from them; recycling concepts
- Increased safety and comfort as well as reduced consumption of resources in the areas of transportation technology, machine and plant engineering, construction and housing
- More efficient systems for energy production, conversion, storage, and distribution
- Improving biocompatibility and the functionality of materials used in medicine and biotechnology and the development of improved material systems for medical diagnosis, prevention, and treatment
- Improved protection of people, buildings, and infrastructure using high-performance materials in unique protection concepts

Chairman of the Group

Prof. Dr.-Ing. Peter Elsner

Deputy Chairman of the Group

Prof. Dr. Ralf B. Wehrspohn

Contacts Fraunhofer IFAM

Prof. Dr.-Ing. habil. Matthias Busse
matthias.busse@ifam.fraunhofer.de

Prof. Dr. Bernd Mayer

bernd.mayer@ifam.fraunhofer.de

> www.materials.fraunhofer.de/en.html

FRAUNHOFER ALLIANCES

Fraunhofer Institutes or divisions of institutes with different expertise collaborate in Fraunhofer Alliances in order to jointly develop and market a specific field of business.

FRAUNHOFER AUTOMOBILE PRODUCTION ALLIANCE

Contacts at Fraunhofer IFAM
Dipl.-Ing. Franz-Josef Wöstmann
franz-josef.woestmann@ifam.fraunhofer.de
Dr.-Ing. Heinrich Kordy
heinrich.kordy@ifam.fraunhofer.de

> www.automobil.fraunhofer.de/en.html

FRAUNHOFER ADDITIVE MANUFACTURING ALLIANCE

Contacts at Fraunhofer IFAM
Dipl.-Ing. Claus Aumund-Kopp
claus.aumund-kopp@ifam.fraunhofer.de
Dr. Burghardt Klöden
burghardt.kloeden@ifam-dd.fraunhofer.de

> www.generativ.fraunhofer.de/en.html

FRAUNHOFER BATTERY ALLIANCE

Contact at Fraunhofer IFAM
Dr. Julian Schwenzel
julian.schwenzel@ifam.fraunhofer.de

> www.batterien.fraunhofer.de/en.html

FRAUNHOFER LIGHTWEIGHT DESIGN ALLIANCE

Contacts at Fraunhofer IFAM
Dr. Markus Brede
markus.brede@ifam.fraunhofer.de
Dr.-Ing. Olaf Andersen
olaf.andersen@ifam-dd.fraunhofer.de

> www.leichtbau.fraunhofer.de

FRAUNHOFER NANOTECHNOLOGY ALLIANCE

Contacts at Fraunhofer IFAM
Prof. Dr. Andreas Hartwig
andreas.hartwig@ifam.fraunhofer.de
Dr. Volker Zöllmer
volker.zoellmer@ifam.fraunhofer.de

> www.nano.fraunhofer.de/english/index.html

**FRAUNHOFER
POLYMER SURFACES (POLO®) ALLIANCE**

Contact at Fraunhofer IFAM
Dr. Uwe Lommatzsch
uwe.lommatzsch@ifam.fraunhofer.de

> www.polo.fraunhofer.de/en.html

**FRAUNHOFER
SPACE ALLIANCE**

Contact at Fraunhofer IFAM
Gerhard Pauly
gerhard.pauly@ifam.fraunhofer.de

> www.space.fraunhofer.de/en.html

**FRAUNHOFER
CLEANING TECHNOLOGY ALLIANCE**

Contact at Fraunhofer IFAM
Dr. Jörg Ihde
joerg.ihde@ifam.fraunhofer.de

> www.allianz-reinigungstechnik.de/en.html

**FRAUNHOFER
TRANSPORT ALLIANCE**

Contact at Fraunhofer IFAM
Dr.-Ing. Gerald Rausch
gerald.rausch@ifam.fraunhofer.de

> www.verkehr.fraunhofer.de/en.html

**FRAUNHOFER
SIMULATION ALLIANCE**

Contact at Fraunhofer IFAM
Andreas Burbliès
andreas.burbliès@ifam.fraunhofer.de

> www.simulation.fraunhofer.de/

FRAUNHOFER ACADEMY

Fraunhofer Academy is the umbrella organization for training courses that are offered by the Fraunhofer-Gesellschaft.

Contacts at Fraunhofer IFAM
Prof. Dr. Andreas Groß
andreas.gross@ifam.fraunhofer.de
www.bremen-bonding.com
www.bremen-composites.com
Dr.-Ing. Gerald Rausch
gerald.rausch@ifam.fraunhofer.de

> www.academy.fraunhofer.de/en.html

EDITORIAL NOTES

Directors

Prof. Dr.-Ing. habil. Matthias Busse
Shaping and Functional Materials
Phone +49 421 2246-100
Fax +49 421 2246-300

Prof. Dr. Bernd Mayer
Adhesive Technology and Surfaces
Phone +49 421 2246-401
Fax +49 421 2246-430

Bremen

Fraunhofer Institute for Manufacturing Technology
and Advanced Materials IFAM
Wiener Strasse 12
28359 Bremen, Germany
Phone +49 421 2246-0
info@ifam.fraunhofer.de
www.ifam.fraunhofer.de

Dresden branch

Fraunhofer Institute for Manufacturing Technology
and Advanced Materials IFAM
Winterbergstrasse 28
01277 Dresden, Germany
Phone +49 351 2537-300
info@ifam-dd.fraunhofer.de
www.ifam-dd.fraunhofer.de

Publisher

© Fraunhofer Institute for Manufacturing Technology
and Advanced Materials IFAM

ISSN 1439-6009 | All rights reserved.
Reproduction subject to approval by the editor.

Coordination and editing

Stephanie Uhlich, M. A.
Dipl.-Biol. Martina Ohle

External service providers

Layout and design

Dipl. Grafik-Designer Gerhard Bergmann

Print and manufacturing

Berlin Druck GmbH

Photo acknowledgments

All Images © Fraunhofer IFAM, unless indicated otherwise.

We would like to extend special thanks this year to employees
who provided images for our internal photo competition.

Follow us



**Fraunhofer Institute for
Manufacturing Technology and
Advanced Materials IFAM**

**info@ifam.fraunhofer.de
www.ifam.fraunhofer.de**